

**EXPERIMENTAL SITE WIND
AVAILABILITY STUDY FOR
TSUEN WAN (EXISTING
CONFIGURATION), HONG KONG**

INVESTIGATION REPORT WWTF006-2007

Original submission: October 2007

Revised submission: June 2008

**submitted to Department of Architecture,
The Chinese University of Hong Kong**

EXECUTIVE SUMMARY

At the request of the Department of Architecture, The Chinese University of Hong Kong, on behalf of Planning Department of The Government of Hong Kong Special Administrative Region, a study of wind availability and characteristics for the “Urban Climate Map and Standards for Wind Environment – Feasibility Study” was conducted by the CLP Power Wind/Wave Tunnel Facility (WWTF) at The Hong Kong University of Science and Technology. The study was undertaken in accordance with the current international best practice requirements stipulated in the Australasian Wind Engineering Society Quality Assurance Manual, AWES-QAM-1-2001 (2001) and the American Society of Civil Engineers Manual and Report on Engineering Practice No. 67 for Wind Tunnel Studies of Buildings and Structures (1999). The study was also conducted in accordance with the recommendations of Planning Department’s Feasibility Study for Establishment of Air Ventilation Assessment System – Final Report (2005) and Technical Guide for Air Ventilation Assessment for Developments in Hong Kong (2005).

A 1:2000 scale topographical study was undertaken to determine the effects of local topography and the surrounding urban environment on mean wind direction, mean wind speed and turbulence intensity at a nominated study area in Tsuen Wan, in accordance with the instructions of Planning Department on 17 January 2007 and 2 March 2007.

A miniature pressure probe was used to take measurements of three components of wind speed, i.e. in the longitudinal, lateral and vertical directions, at 22.5° increments for the full 360° azimuth, i.e. for sixteen (16) wind directions, and at nine (9) heights to determine profiles of mean wind speed and turbulence intensity above the study area that will be used as input boundary conditions for later more detailed benchmarking studies. The 1:2000 scale topographical model included the surrounding area up to a distance of approximately 10 km from the study area.

The topographical study results were combined with WWTF’s statistical model of the Hong Kong wind climate, based on measurements of non-typhoon winds taken by Hong Kong Observatory at Waglan Island during the period of 1953 – 2000 inclusive, to determine wind roses corresponding to annual mean wind speeds at the study area.

The annual and summer (i.e. June, July, August) prevailing wind characteristics corresponding to strong non-typhoon winds approaching Hong Kong also occurred at a height of 500 m above the Tsuen Wan study area. However, at heights of 50 m and 100 m above the study area, winds from directions of 90°, 112.5°, 135°, 292.5°, 315° and 337.5° were significantly affected by the topography surrounding the study area which caused significant changes to the wind rose at those heights. Similarly, at a height of 200 m, winds from directions of 112.5° and 315° were also significantly affected by the surrounding topography. Winds approaching from westerly directions were the least affected due to the area's relatively open exposure in those directions.

TABLE OF CONTENTS

EXECUTIVE SUMMARY	i
1. INTRODUCTION	1
2. ANALYSIS OF THE HONG KONG WIND CLIMATE	2
3. WIND TUNNEL STUDY	5
3.1 Modelling the Natural Wind	5
3.2 Physical Model of the Study Area	8
3.3 Experimental and Analysis Procedures	8
4. EXPERIMENTAL RESULTS AND DISCUSSION	10
5. CONCLUSIONS	13
6. REFERENCES	14
APPENDIX A TABULATED RESULTS FOR TSUEN WAN	46
APPENDIX B AXIS SYSTEM OF THE COBRA PROBE	52

LIST OF TABLES

Table A1	Site wind characteristics, Tsuen Wan, 22.5°	46
Table A2	Site wind characteristics, Tsuen Wan, 45°	46
Table A3	Site wind characteristics, Tsuen Wan, 67.5°	46
Table A4	Site wind characteristics, Tsuen Wan, 90°	47
Table A5	Site wind characteristics, Tsuen Wan, 112.5°	47
Table A6	Site wind characteristics, Tsuen Wan, 135°	47
Table A7	Site wind characteristics, Tsuen Wan, 157.5°	48
Table A8	Site wind characteristics, Tsuen Wan, 180°	48
Table A9	Site wind characteristics, Tsuen Wan, 202.5°	48
Table A10	Site wind characteristics, Tsuen Wan, 225°	49
Table A11	Site wind characteristics, Tsuen Wan, 247.5°	49
Table A12	Site wind characteristics, Tsuen Wan, 270°	49
Table A13	Site wind characteristics, Tsuen Wan, 292.5°	50
Table A14	Site wind characteristics, Tsuen Wan, 315°	50
Table A15	Site wind characteristics, Tsuen Wan, 337.5°	50
Table A16	Site wind characteristics, Tsuen Wan, 360°	51

LIST OF FIGURES

Figure 1	Tsuen Wan study area	16
Figure 2	Wind rose for annual, non-typhoon winds, Waglan Island, corrected to 500 m, 1953-2000	17
Figure 3	Wind rose for summer, non-typhoon winds, Waglan Island, corrected to 500 m, 1953-2000	18
Figure 4	Test sections at the CLP Power Wind/Wave Tunnel Facility	19
Figure 5	Simulated mean wind speed and turbulence intensity profiles – approach wind	20
Figure 6	Longitudinal turbulence spectrum – approach wind	20
Figure 7	A 1:2000 scale topographical model of Tsuen Wan, Hong Kong in the low speed test section of the CLP Power Wind/Wave Tunnel Facility (south wind direction)	21
Figure 8a	Wind characteristics, Tsuen Wan, 22.5°	22
Figure 8b	Mean wind direction, Tsuen Wan, 22.5°	22
Figure 9a	Wind characteristics, Tsuen Wan, 45°	23
Figure 9b	Mean wind direction, Tsuen Wan, 45°	23
Figure 10a	Wind characteristics, Tsuen Wan, 67.5°	24
Figure 10b	Mean wind direction, Tsuen Wan, 67.5°	24
Figure 11a	Wind characteristics, Tsuen Wan, 90°	25
Figure 11b	Mean wind direction, Tsuen Wan, 90°	25
Figure 12a	Wind characteristics, Tsuen Wan, 112.5°	26
Figure 12b	Mean wind direction, Tsuen Wan, 112.5°	26
Figure 13a	Wind characteristics, Tsuen Wan, 135°	27
Figure 13b	Mean wind direction, Tsuen Wan, 135°	27
Figure 14a	Wind characteristics, Tsuen Wan, 157.5°	28
Figure 14b	Mean wind direction, Tsuen Wan, 157.5°	28
Figure 15a	Wind characteristics, Tsuen Wan, 180°	29
Figure 15b	Mean wind direction, Tsuen Wan, 180°	29
Figure 16a	Wind characteristics, Tsuen Wan, 202.5°	30
Figure 16b	Mean wind direction, Tsuen Wan, 202.5°	30

Figure 17a	Wind characteristics, Tsuen Wan, 225°	31
Figure 17b	Mean wind direction, Tsuen Wan, 225°	31
Figure 18a	Wind characteristics, Tsuen Wan, 247.5°	32
Figure 18b	Mean wind direction, Tsuen Wan, 247.5°	32
Figure 19a	Wind characteristics, Tsuen Wan, 270°	33
Figure 19b	Mean wind direction, Tsuen Wan, 270°	33
Figure 20a	Wind characteristics, Tsuen Wan, 292.5°	34
Figure 20b	Mean wind direction, Tsuen Wan, 292.5°	34
Figure 21a	Wind characteristics, Tsuen Wan, 315°	35
Figure 21b	Mean wind direction, Tsuen Wan, 315°	35
Figure 22a	Wind characteristics, Tsuen Wan, 337.5°	36
Figure 22b	Mean wind direction, Tsuen Wan, 337.5°	36
Figure 23a	Wind characteristics, Tsuen Wan, 360°	37
Figure 23b	Mean wind direction, Tsuen Wan, 360°	37
Figure 24	Wind rose for annual, non-typhoon winds for Tsuen Wan, existing configuration, corrected to 50 m	38
Figure 25	Wind rose for annual, non-typhoon winds for Tsuen Wan, existing configuration, corrected to 100 m	39
Figure 26	Wind rose for annual, non-typhoon winds for Tsuen Wan, existing configuration, corrected to 200 m	40
Figure 27	Wind rose for annual, non-typhoon winds for Tsuen Wan, existing configuration, corrected to 500 m	41
Figure 28	Wind rose for summer, non-typhoon winds for Tsuen Wan, existing configuration, corrected to 50 m	42
Figure 29	Wind rose for summer, non-typhoon winds for Tsuen Wan, existing configuration, corrected to 100 m	43
Figure 30	Wind rose for summer, non-typhoon winds for Tsuen Wan, existing configuration, corrected to 200 m	44
Figure 31	Wind rose for summer, non-typhoon winds for Tsuen Wan, existing configuration, corrected to 500 m	45
Figure B1a	Flow axis system with respect to the Cobra Probe head	52
Figure B1b	Positive flow pitch and yaw angles	52

1. INTRODUCTION

At the request of the Department of Architecture, The Chinese University of Hong Kong, on behalf of Planning Department of The Government of Hong Kong Special Administrative Region (PlanD), a wind engineering study was conducted by the CLP Power Wind/Wave Tunnel Facility at The Hong Kong University of Science and Technology for the study of wind availability and characteristics within a nominated study area in Tsuen Wan as part of the “Urban Climate Map and Standards for Wind Environment – Feasibility Study”. The study was undertaken in accordance with the current international best practice requirements stipulated in the Australasian Wind Engineering Society Quality Assurance Manual, AWES-QAM-1-2001 (2001) and the American Society of Civil Engineers Manual and Report on Engineering Practice No. 67 for Wind Tunnel Studies of Buildings and Structures (1999). The study was also conducted in accordance with the recommendations of Planning Department’s Feasibility Study for Establishment of Air Ventilation Assessment System – Final Report (2005) and Technical Guide for Air Ventilation Assessment for Developments in Hong Kong (2005).

The study area of Tsuen Wan is centred close to the junction of Yeung Uk Road and Ma Tau Pa Road, as shown in Figure 1. A 1:2000 scale topographical study was undertaken to determine the effects of local topography and the existing surrounding urban environment on mean wind speeds and turbulence intensities at the study area. The topographical study results were combined with WWTF’s statistical model of the Hong Kong wind climate, based on measurements of non-typhoon winds taken by Hong Kong Observatory at Waglan Island during the period of 1953 – 2000 inclusive, to determine site-specific annual and summer wind roses for hourly mean wind speeds.

2. ANALYSIS OF THE HONG KONG WIND CLIMATE

Waglan Island, located approximately 5 km southeast of Hong Kong Island, has been used by Hong Kong Observatory (HKO), formerly The Royal Observatory, Hong Kong, for the collection of long-term wind data since December 1952 and that data is considered to be of the highest quality available for all wind engineering purposes for Hong Kong. Due to its location, relative lack of development over the past 50 years and its generally uninterrupted exposure to winds, data collected at Waglan Island is considered to be representative of winds approaching the Hong Kong region. The detrimental effects of nearby developments on the usefulness of wind data were clearly demonstrated by Melbourne (1984) in a comparison of wind speed measurements taken at both Waglan Island and Hong Kong Observatory in Tsim Sha Tsui. Similarly, for other HKO measurement and monitoring sites, such as at Tsim Sha Tsui and the Kowloon Star Ferry Piers, the amount and variety of nearby development that has taken place during their operational life makes them unsuitable for use for both structural and environmental wind engineering applications. The study of Melbourne (1984) also demonstrated that further anemometer position error corrections are required to account for the effects of the location and height of an anemometer station, the surrounding topography and buildings, even for those stations that are considered suitable for wind engineering applications.

Waglan Island wind records have been analysed previously in studies of the Hong Kong wind climate, most notably by Davenport et al. (1984), Melbourne (1984) and Hitchcock et al. (2003). Melbourne (1984) conducted wind tunnel model studies to determine directional factors relating wind speeds at each anemometer location to the wind speed at a height equivalent to 50 m in the freestream flow and concluded that:

- Measurements taken during the period 1 January 1964 to 11 July 1966 inclusive were directly and adversely affected by the effects of building on which it was mounted; therefore, records from that period were excluded from that study.
- The anemometer correction factors for mean wind speeds show some sensitivity to the modelled approach flow but they are not strongly dependent on the modelled approach profiles.
- The largest magnitude speed-up effects occur for winds approaching from approximately 67.5° , 180° , 270° and 360° .
- The largest magnitude slow-down effects occur for winds approaching from approximately 112.5° , 225° and 315° .

In the study conducted by Hitchcock et al. (2003), wind tunnel tests were undertaken to correct wind records for position and topographical effects at the four anemometer locations used since 1952, with the exception of the location used during the period 1 January 1964 to 11 July 1966 inclusive. In that study, thermal (hotwire) anemometer measurements were taken at 22.5° intervals for the full 360° azimuth relating wind speeds at anemometer height to wind speeds at a height equivalent to 200 m in the freestream. The directional characteristics of the former anemometer sites were found to be similar to those discussed by Davenport et al. (1984) and Melbourne (1984), whereas the current anemometer site is much less affected than its predecessors, mainly due to its additional height.

Correction factors were determined and subsequently applied to non-typhoon wind data collected at Waglan Island to determine a probability distribution of directional mean wind speeds for Hong Kong. The annual wind rose for mean wind speeds at a height equivalent to 500 m above Waglan Island is presented in Figure 2 and indicates that, on an annual basis,

prevailing and strong non-typhoon winds approaching Hong Kong occur mainly from the north-east quadrant and, to a lesser extent, the south-west quadrant. The summer (i.e. June, July, August) wind rose for mean wind speeds at a height equivalent to 500 m above Waglan Island is presented in Figure 3. In contrast to the corresponding annual wind rose, prevailing and strong non-typhoon winds approaching Hong Kong during summer months occur mainly from the south-east and south-west quadrants.

In Figures 2 and 3, mean wind speeds are segregated into four categories (0 – 3.3 m/s, 3.4 – 7.9 m/s, 8.0 – 13.8 m/s and greater than 13.8 m/s) that are indicated by the thickness of the bars for the 16 cardinal wind directions. The length of the bars indicates the average percentage of occurrence per year. For example, Figure 2 illustrates that, on an annual basis, east winds occur approximately 24% of the time and hourly mean wind speeds exceed 13.8 m/s approximately 6% of the time at a height of 500 m.

3. WIND TUNNEL STUDY

The wind tunnel test techniques used in this investigation were undertaken in accordance with the procedures and recommendations of the Australasian Wind Engineering Society Quality Assurance Manual, AWES QAM-1-2001 (2001) and the American Society of Civil Engineers Manual and Report on Engineering Practice No. 67 for Wind Tunnel Studies of Buildings and Structures (1999). Those requirements cover the satisfactory modelling of the turbulent natural wind, the accuracy of the wind tunnel models, experimental and analysis procedures and quality assurance.

3.1 Modelling the Natural Wind

Air moving relative to the Earth's surface has frictional forces imparted on it, which effectively cause it to be slowed down. These forces have a decreasing effect on air flow as the height above ground increases, generally resulting in mean wind speed increasing with height to a point where the effects of surface drag become negligible. In wind engineering, a convenient measure of the thickness of the atmospheric boundary layer is commonly referred to as the gradient height which will vary depending on the surrounding surface roughness over which the air will flow. Obstacles to air flow can vary from relatively large expanses of smooth, open water, to vegetation such as forests, built-up environments such as city centres, and large, rugged mountain ranges. The resulting gradient heights typically vary from several hundred metres to in excess of 1000 m.

Winds within the atmospheric boundary layer are also usually highly turbulent or gusty. Turbulence intensity is a measure of the gustiness of wind due to eddies and vortices

generated by frictional effects at surface level, the roughness of the terrain over which air is flowing and convective effects due to opposing movements of air masses of different temperature. In typical atmospheric boundary layer flow, turbulence intensity generally decreases with height. Closer to the ground, at pedestrian level for example, the magnitude of the turbulence intensity can be very large due to the effects of wind flowing around buildings and other structures.

In conducting wind tunnel model studies of wind characteristics and wind effects on and around tall buildings and other structures on the surface of the Earth, it is necessary to adequately simulate the atmospheric boundary layer. WWTF's boundary layer wind tunnel test sections can be used to simulate atmospheric boundary layer flow over various types of terrain, ranging from open terrain, such as open water, to urban or mountainous terrain.

WWTF comprises two long fetch boundary layer wind tunnel test sections as shown in Figure 4. The 28 m long high speed test section has a 3 m wide \times 2 m high working section and a maximum freestream wind speed of approximately 30 m/s. The 40 m long low speed test section has a 5 m wide \times 4 m high working section and a maximum freestream wind speed of approximately 10 m/s. Various terrain simulations can be modelled in either test section at length scales ranging from approximately 1:5000 to 1:50.

The wind in the low speed test section of the WWTF can be modified through the use of devices such as spires, grids, and fences to model different scale atmospheric boundary layer flows. For the current study, WWTF's low speed test section was calibrated, by using appropriate combinations of roughness elements, to simulate the characteristics of winds approaching Hong Kong through mean wind speed and turbulence intensity profiles

corresponding to wind flowing over open water. The mean wind speed profile of the wind flow approaching the study area was simulated in accordance with the power law expression, defined in Equation (1), specified in Planning Department's Feasibility Study for Establishment of Air Ventilation Assessment System – Final Report (2005).

$$\frac{\bar{u}(z)}{\bar{u}_{\text{ref}}} = \left(\frac{z}{z_{\text{ref}}} \right)^{\alpha} \quad (1)$$

where:

$\bar{u}(z)$ = mean wind speed at a height z (m/s);

\bar{u}_{ref} = mean wind speed at a suitable reference height (m/s);

z = height above zero plane displacement height (m);

z_{ref} = a suitable reference height (m);

α = a power law exponent, which is a constant commensurate with the terrain roughness, taken as approximately 0.15 for this study.

The turbulence intensity profile of the approaching wind flow was simulated in accordance with Terrain category 2 stipulated in Australian/New Zealand Standard AS/NZS 1170.2:2002, i.e. corresponding to non-typhoon wind flow above rough open water surfaces.

The simulated mean wind speed and turbulence intensity profiles were generally within $\pm 10\%$ of the target mean speed and turbulence intensity profiles defined and are presented in Figure 5. The spectrum of longitudinal turbulence of the approaching wind flow measured at a height equivalent to 500 m in prototype scale is presented in Figure 6.

3.2 Physical Model of the Study Area

WWTF has a 1:2000 scale topographical model of the New Territories, Kowloon and Hong Kong Island fabricated at 20 m contour intervals from information acquired from the HKSAR's Survey and Mapping Office, Lands Department. The relevant sections of the topographical model were updated to include all known current buildings and the major topographical features in the urban landscapes of Hong Kong Island, Kowloon Peninsula and the New Territories. For all wind directions tested, the wind tunnel model included surrounding areas within a distance of up to approximately 10 km from the study area.

The topographical model was updated to include greater detail within a zone from 500 m up to approximately 1000 m from the measurement positions. In accordance with information supplied by PlanD on 21 February 2007, all known existing buildings and structures at the time of testing were included in the model to represent their effects on wind flow approaching the study area. Beyond the 1000 m radius, the topographical model included roughness representative of the surrounding areas. A representative view of the 1:2000 scale topographical model used in the current study is shown in Figure 7.

3.3 Experimental and Analysis Procedures

The terrain surrounding the study area comprises complex mixtures of open water, urban and built-up environment, and mountainous areas on Hong Kong Island, Kowloon Peninsula and the New Territories. Winds approaching the modelled region were scaled to simulate non-typhoon winds flowing over open water and the topographical model was used to determine

the modifying effects of the surrounding complex terrain on the wind speed and turbulence intensity above the study area.

Wind tunnel measurements were taken using a miniature dynamic pressure probe, a Cobra probe manufactured by Turbulent Flow Instrumentation Pty Ltd, at 22.5° intervals for the full 360° azimuth (i.e. 16 wind directions, θ), where a wind direction of 0° or 360° corresponds to an incident wind approaching the study area directly from the north, 90° corresponds to an incident wind approaching the study area directly from the east, etc. For each wind direction tested, mean wind speeds and turbulence intensities were measured at heights equivalent to 25, 50, 75, 100, 150, 200, 300, 400 and 500 m in prototype scale, above the centre of the study area.

While measurements were taken at the study area, all buildings within a radius of 500 m of the centre of the study area were removed from the wind tunnel model for all measured wind directions. All buildings within the radius of 500 m will be included in the proximity model for the more detailed 1:400 scale benchmarking study to be conducted later, to directly account for their effects on the wind flow within the study area.

4. EXPERIMENTAL RESULTS AND DISCUSSION

For each wind direction tested, results of the 1:2000 scale topographical study are presented in graphical format in Figures 8 to 23 inclusive and in tabular format in Appendix A. In Figures 8a to 23a, the normalised wind characteristics include mean wind speed profiles and turbulence intensity profiles. Mean wind speed profiles were determined by normalising the local mean wind speeds with respect to the mean wind speed of the approaching wind flow measured at a height equivalent to 500 m, as defined in Equation (2). Vertical profiles of turbulence intensity, defined in Equation (3), are also presented in Figures 8a to 23a. Yaw and pitch angles, i.e. the lateral and vertical deviations respectively of the local mean wind direction relative to the approaching mean wind direction, are presented in Figures 8b to 23b inclusive. The sign conventions used to define yaw angles and pitch angles are provided in Appendix B.

The profiles of longitudinal mean wind speed and turbulence intensity will be used as input boundary conditions for the more detailed AVA benchmarking studies for each study area.

$$\text{normalised wind velocity} = \frac{\bar{V}_z(\theta)}{\bar{V}_{500,\text{approach}}(\theta)} \quad (2)$$

$$\text{turbulence intensity} = \frac{\sigma_{v,z}(\theta)}{\bar{V}_z(\theta)} \quad (3)$$

In Equations (2) and (3):

$\bar{V}_z(\theta)$ = mean wind speed at a height z ($z = 25, 50, 75, 100, 150, 200, 300, 400$ or 500 m in prototype scale) for an approaching wind direction θ ($\theta = 22.5^\circ, 45^\circ, 67.5^\circ, 90^\circ, 112.5^\circ, 135^\circ, 157.5^\circ, 180^\circ, 202.5^\circ, 225^\circ, 247.5^\circ, 270^\circ, 292.5^\circ, 315^\circ, 337.5^\circ$ or 360°);

$\bar{V}_{500, \text{approach}}(\theta)$ = mean wind speed of the approaching wind at a height equivalent to 500 m in prototype scale for an approaching wind direction θ ;

$\sigma_{V_z}(\theta)$ = the standard deviation of the fluctuating wind speed V_z for an approaching wind direction θ .

The presence of Tai Mo Shan to the north of the study area had significant effects on the wind characteristics at the study area, particularly for wind directions in the range of 337.5° to 22.5° inclusive for which the magnitudes of the measured mean wind speed profiles were reduced significantly over the range of measurement heights. For winds approaching from 90° to 135° inclusive, the combination of mountains located to the southeast of the study area, such as Golden Hill, the large mountains around Tai Mo Shan and the built-up areas in Kwai Chung are believed to be responsible for the significant increases in turbulence intensity, decreased mean wind speeds and large yaw angles.

The measured turbulence intensities for winds approaching from 247.5° to 292.5° are relatively low due to the relatively open exposures in these directions. A comparison of the existing configuration results with the results previously reported for the Tsuen Wan study area with proposed developments (WWTF Investigation Report WWTF005-2007) demonstrates that the group of proposed buildings located near the KCRC Tsuen Wan West Station are likely to affect both mean wind speeds and turbulence intensities for winds approaching from 270° and 292.5°, particularly at heights below approximately 200 m.

The topographical study measurements were also used to determine directional factors for the 16 measured wind directions, relating the mean wind speeds at heights equivalent to 50 m, 100 m, 200 m and 500 m above the study area to the mean wind speed of the approach flow

at a reference height of 500 m. These directional factors were then applied to WWTF's Hong Kong non-typhoon wind climate model, derived from HKO's Waglan Island wind data as discussed in Section 2 of this report, to determine site-specific wind roses pertaining to annual and summer hourly mean wind speeds at heights of 50 m, 100 m, 200 m and 500 m above the study area. The annual wind roses are presented in Figures 24, 25, 26 and 27 for heights of 50 m, 100 m, 200m and 500 m above the Tsuen Wan study area, respectively for the existing configuration of surrounding buildings. The summer wind roses are presented in Figures 28 29, 30 and 31 for heights of 50 m, 100 m, 200m and 500 m above the Tsuen Wan study area respectively for the existing configuration of surrounding buildings.

A comparison of the annual and summer wind roses for Waglan Island presented in Figures 2 and 3 to those for the Tsuen Wan study area in Figures 27 and 31 illustrates that the overall directional distribution of the upper level wind speed is not significantly changed, although the magnitudes of the wind speeds are reduced. The annual and summer wind roses corresponding to heights of 50 m, 100 m and 200 m above the Tsuen Wan study area in Figures 24, 25,26, 28, 29 and 30 demonstrates further reductions in the overall magnitudes of wind speed. Furthermore, the yaw angles measured for wind directions of 112.5° and 315° at 200 m; 90°, 112.5°, 135°, 292.5° and 315° at both 50 m and 100 m, and for 337.5° at 50 m only, indicated significant changes to the directional characteristics at those heights, as shown in Figures 24, 25, 26, 28, 29 and 30.

5. CONCLUSIONS

A study of wind availability and characteristics was conducted by the CLP Power Wind/Wave Tunnel Facility at The Hong Kong University of Science and Technology for the Tsuen Wan study area as part of the “Urban Climate Map and Standards for Wind Environment – Feasibility Study” administered by the Department of Architecture, The Chinese University of Hong Kong.

A 1:2000 scale topographical study was undertaken to determine the effects of local topography and the surrounding urban environment on mean wind speeds and turbulence intensities above the study area. The topographical study results were subsequently combined with a statistical model of the Hong Kong wind climate, based on measurements of non-typhoon winds taken by Hong Kong Observatory at Waglan Island, to determine directional wind characteristics and availability for the Tsuen Wan study area.

In general, the annual and summer prevailing wind characteristics corresponding to strong non-typhoon winds at a height of 500 m above the Tsuen Wan study area were similar to the overall characteristics of non-typhoon winds approaching the Hong Kong region, although the magnitudes of the directional wind speeds were reduced. However, at a height of 50 m and 100 m above the study area, winds from directions of 90°, 112.5°, 135°, 292.5°, 315° and 337.5° were significantly affected by the surrounding topography that caused significant changes to the wind rose at those heights. Similarly, at a height of 200 m, winds from directions of 112.5° and 315° were also significantly affected by the surrounding topography. Winds approaching from westerly directions were the least affected due to the area’s relatively open exposure in those directions.

6. REFERENCES

Australasian Wind Engineering Society (2001), Wind Engineering Studies of Buildings, AWES-QAM-1-2001.

Buildings Department (HKSAR) (2004), Code of Practice on Wind Effects in Hong Kong.

Davenport, A.G., Georgiou, P.N., Mikić, M., Surry, D. and Kythe, G. (1984), The wind climate of Hong Kong, Proceedings of the Third International Conference on Tall Buildings, Hong Kong and Guangzhou, pp 454 – 460.

Hitchcock, P.A., Kwok, K.C.S. and Yu, C.W. (2003), A study of anemometer measurements at Waglan Island, Hong Kong, Technical Report WWTF002-2003, CLP Power Wind/Wave Tunnel Facility, The Hong Kong University of Science and Technology.

Manual of practice for wind tunnel studies of buildings and structures (1999), Editor Nicholas Isyumov, Task Committee on Wind Tunnel Testing of Buildings and Structures, Aerodynamics Committee, Aerospace Division, American Society of Civil Engineers.

Melbourne, W.H. (1984), Design wind data for Hong Kong and surrounding coastline, Proceedings of the Third International Conference on Tall Buildings, Hong Kong and Guangzhou, pp 461 – 467.

Planning Department, The Government of the Hong Kong Special Administrative Region (2005), Feasibility Study for Establishment of Air Ventilation Assessment – Final Report, Department of Architecture, The Chinese University of Hong Kong.

Planning Department, The Government of the Hong Kong Special Administrative Region (2005), Technical Guide for Air Ventilation Assessment for Developments in Hong Kong.

Planning Department, The Government of the Hong Kong Special Administrative Region (2006), Urban Climatic Map and Standards for Wind Environment- Feasibility Study (Inception Report), The Chinese University of Hong Kong.

Planning Department, The Government of the Hong Kong Special Administrative Region (2006), Urban Climatic Map and Standards for Wind Environment- Feasibility Study (Working Paper 2A: Methodologies of Area Selection for Benchmarking), The Chinese University of Hong Kong.

Standards Australia/Standards New Zealand (2002), Australia/New Zealand Standard, Structural design actions Part 2: Wind actions, AS/NZS 1170.2:2002.

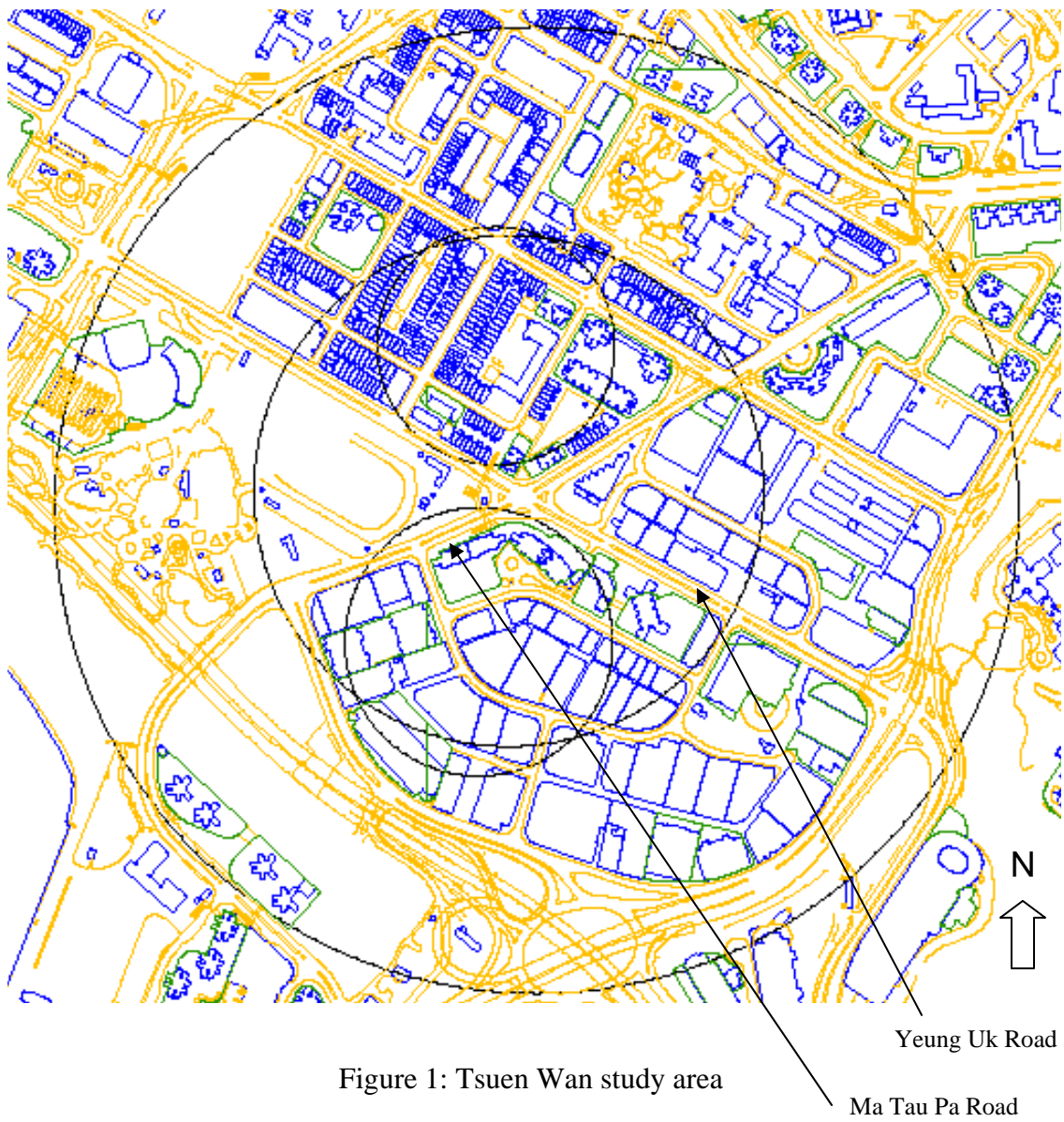

Figure 1: Tsuen Wan study area

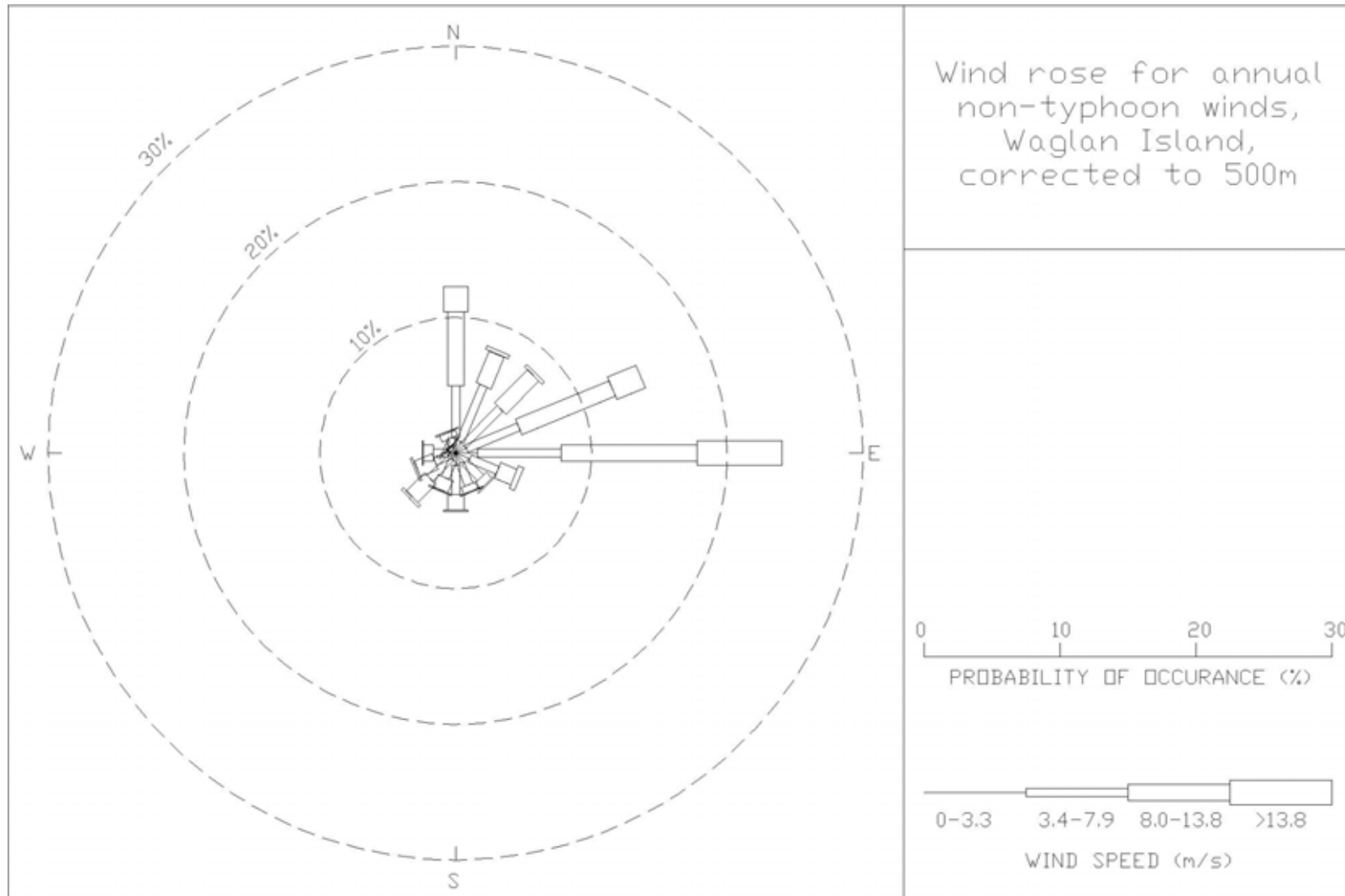

Figure 2: Wind rose for annual, non-typhoon winds, Waglan Island, corrected to 500m, 1953-2000

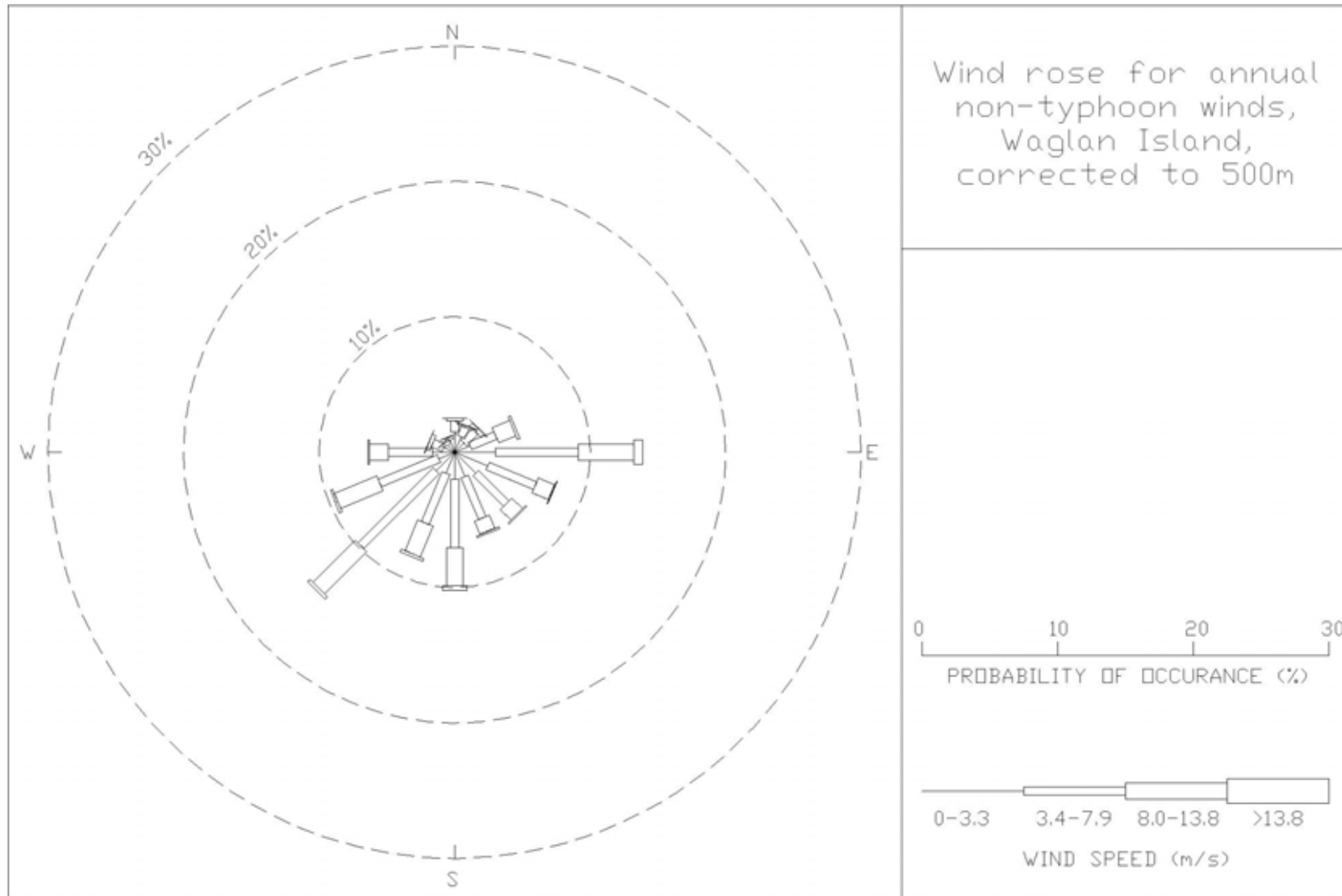

Figure 3: Wind rose for summer, non-typhoon winds, Waglan Island, corrected to 500m, 1953-2000

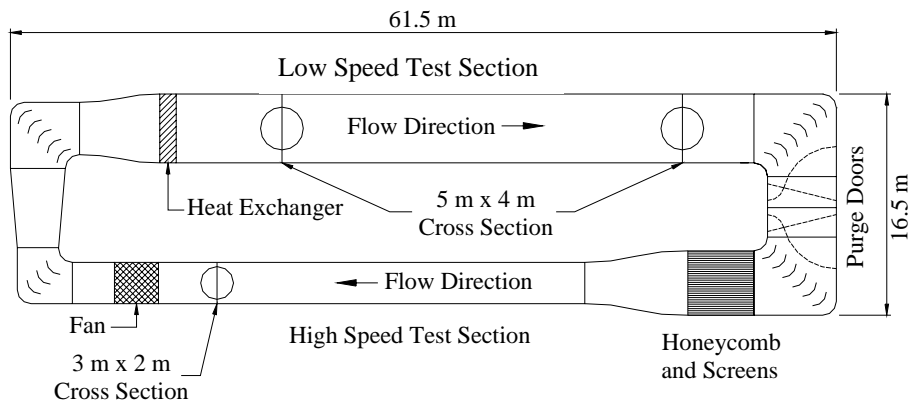

Figure 4: Test sections at the CLP Power Wind/Wave Tunnel Facility

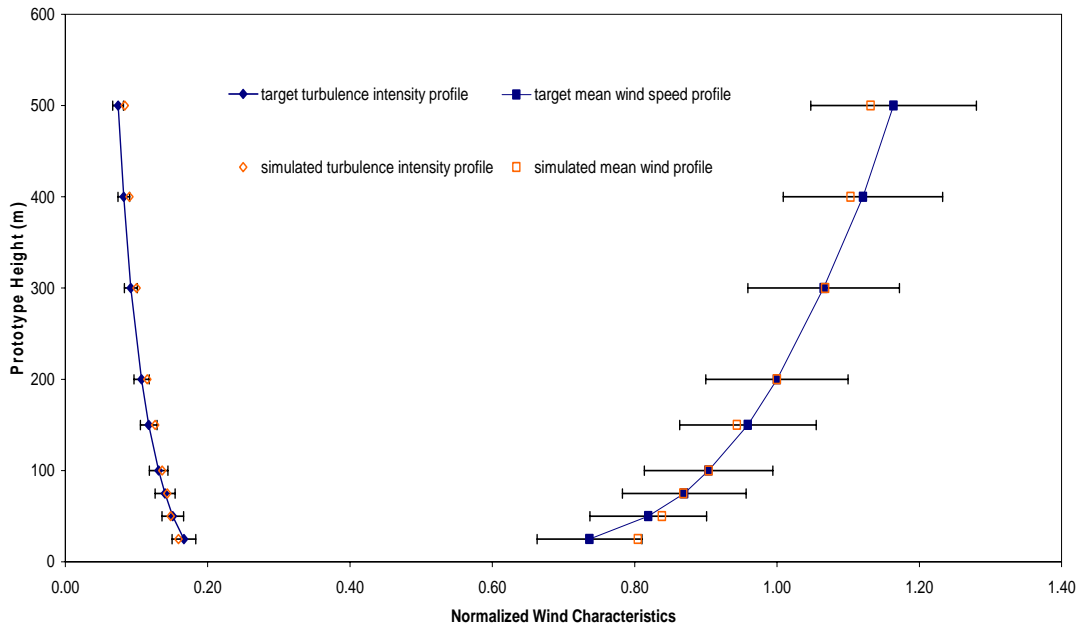

Figure 5: Simulated mean wind speed and turbulence intensity profiles – approach wind

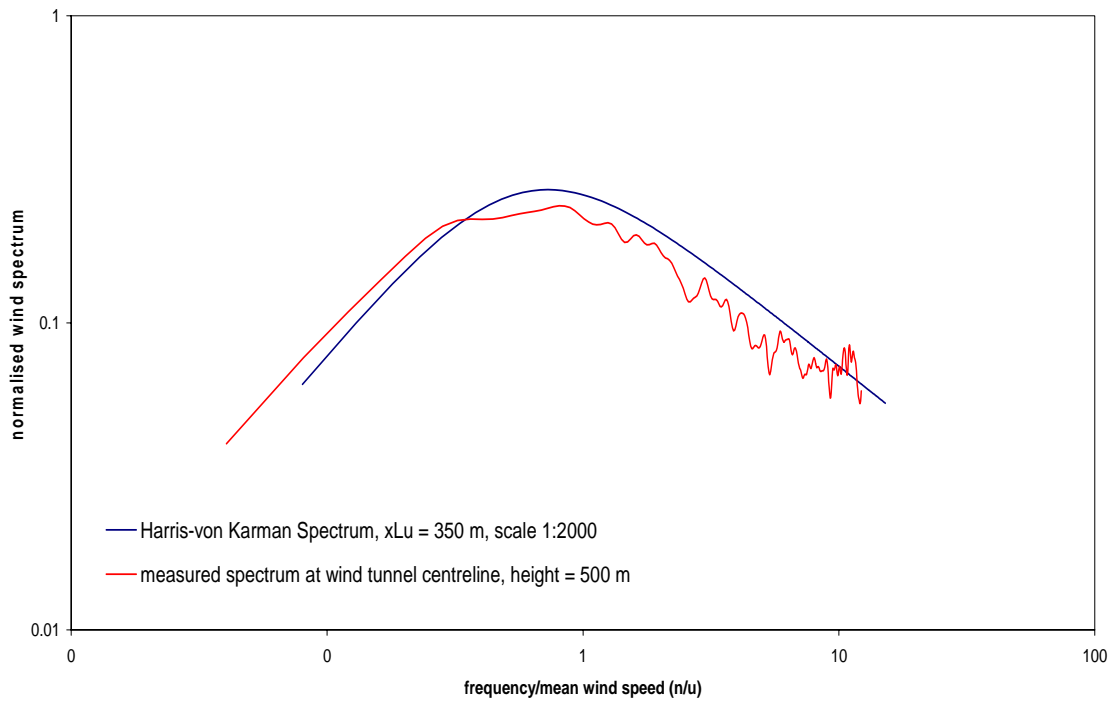

Figure 6: Longitudinal turbulence spectrum – approach wind



Figure 7: A 1:2000 scale topographical model of Tsuen Wan, Hong Kong in the low speed test section of the CLP Power Wind/Wave Tunnel Facility (south wind direction, 180°)

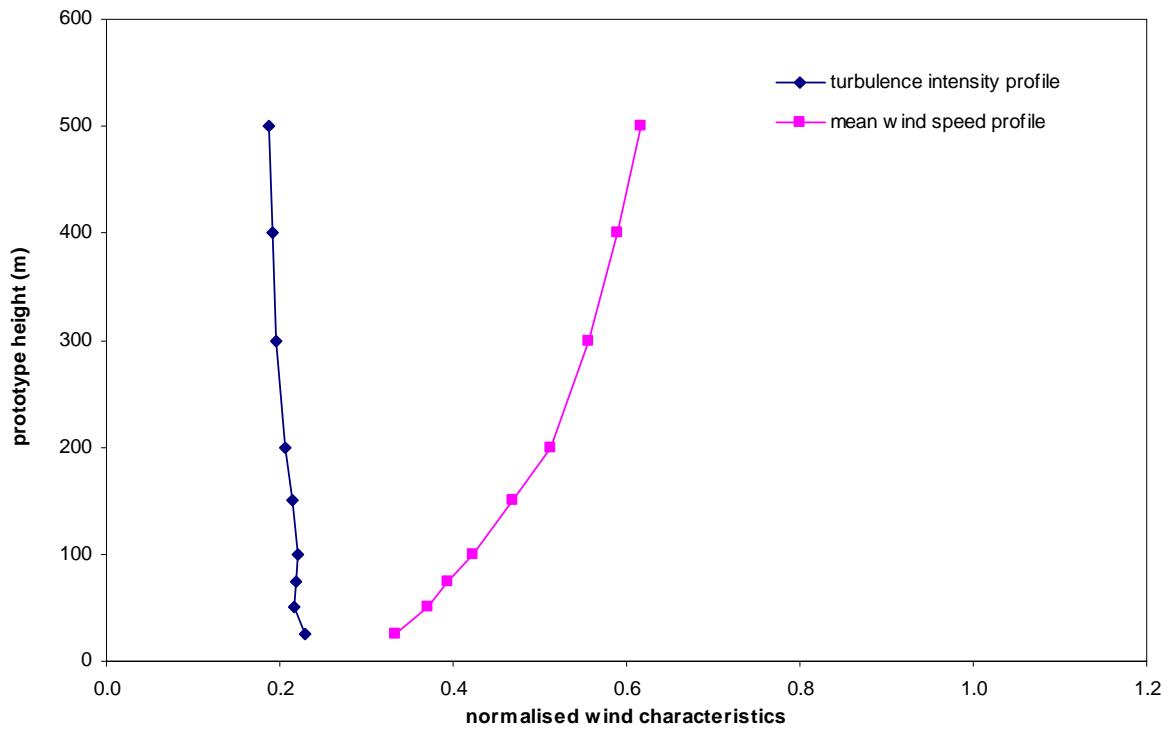

Figure 8a: Wind characteristics, Tsuen Wan, 22.5°

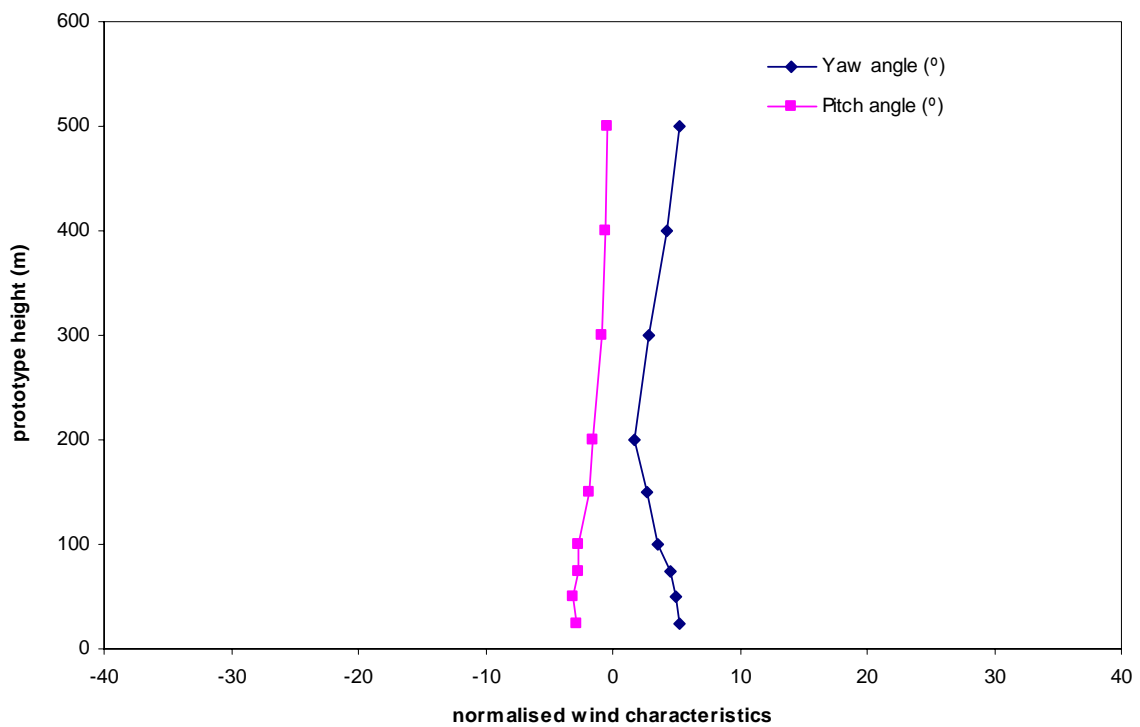

Figure 8b: Mean wind direction, Tsuen Wan, 22.5°

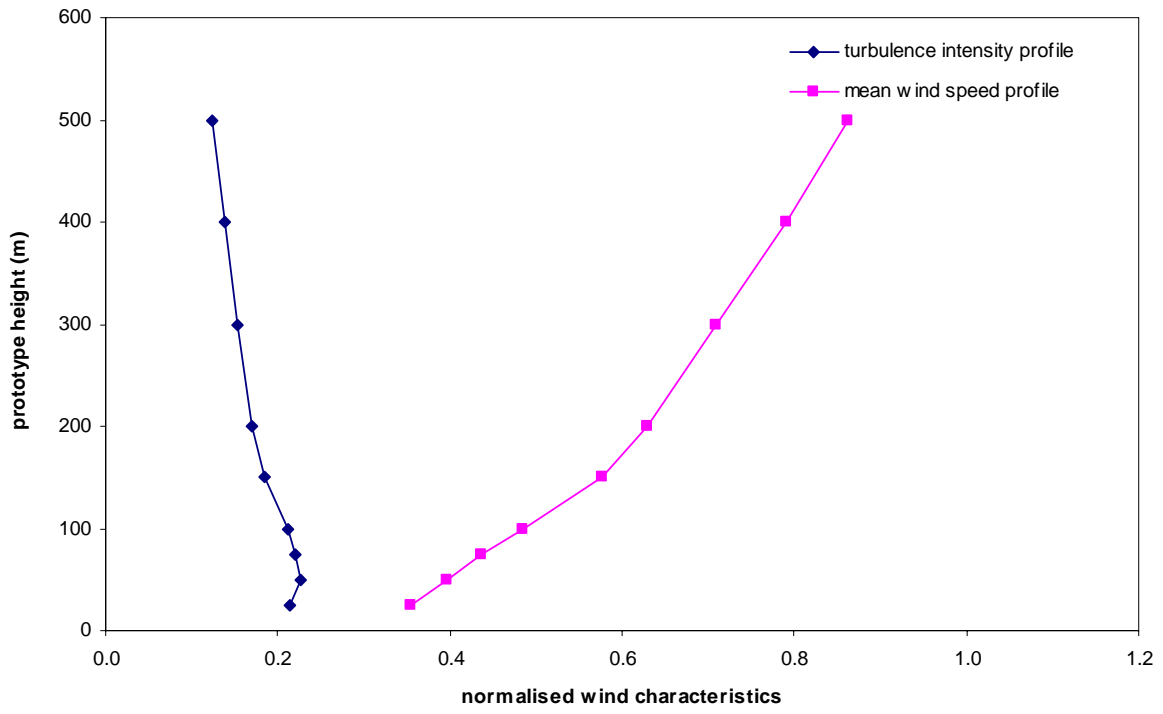

Figure 9a: Wind characteristics, Tsuen Wan, 45°

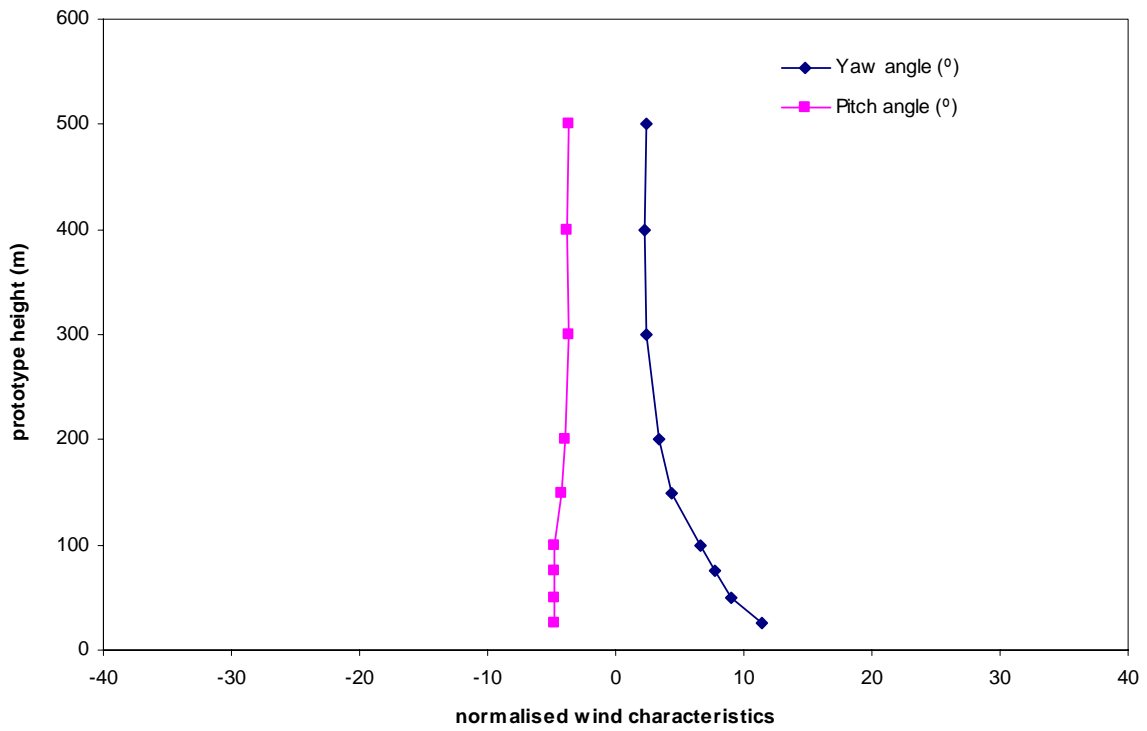

Figure 9b: Mean wind direction, Tsuen Wan, 45°

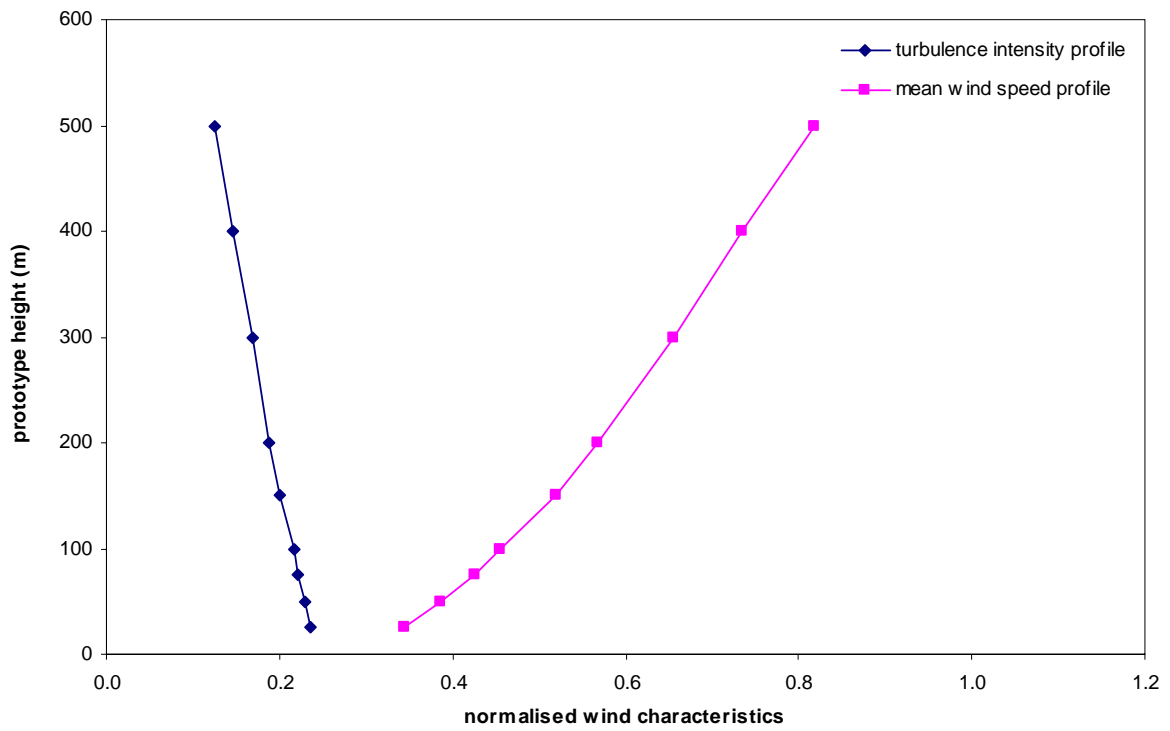

Figure 10a: Wind characteristics, Tsuen Wan, 67.5°

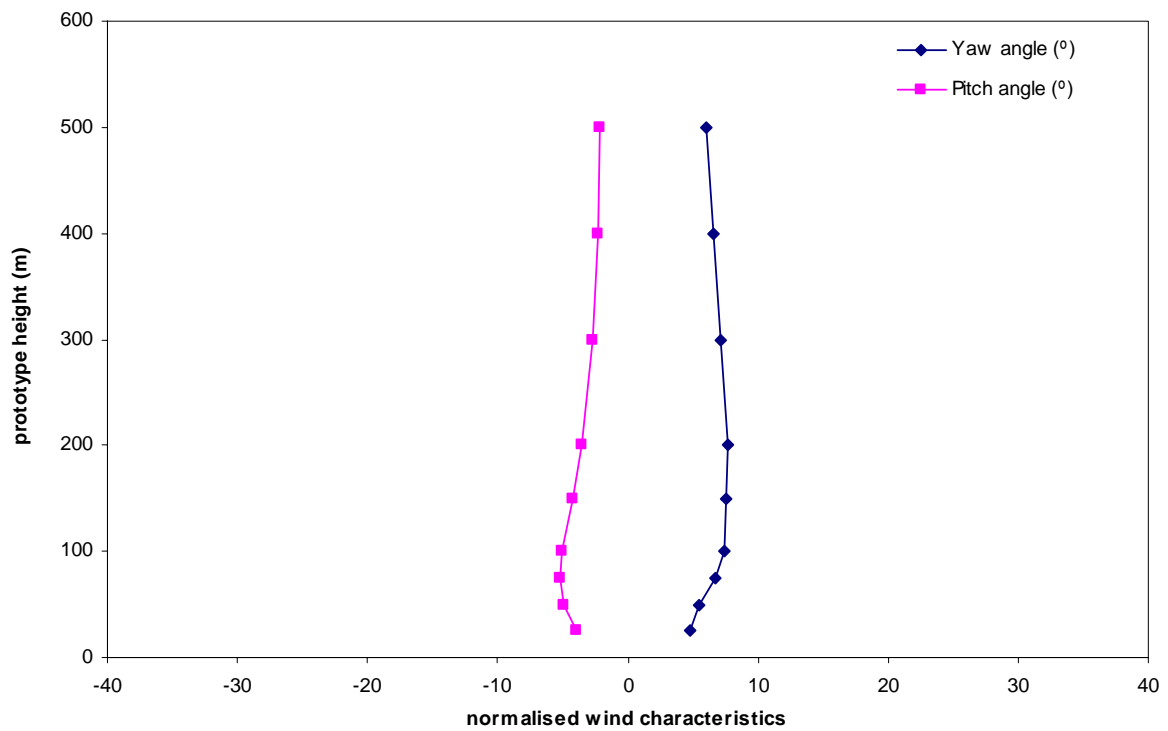

Figure 10b: Mean wind direction, Tsuen Wan, 67.5°

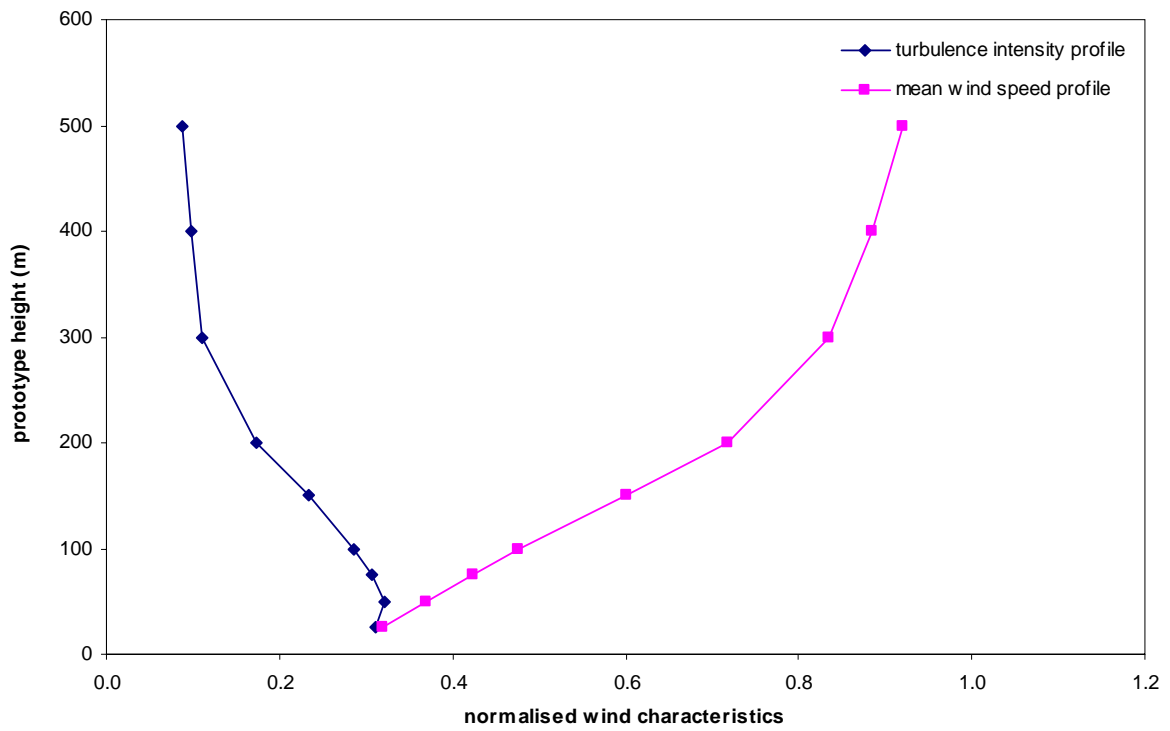

Figure 11a: Wind characteristics, Tsuen Wan, 90°

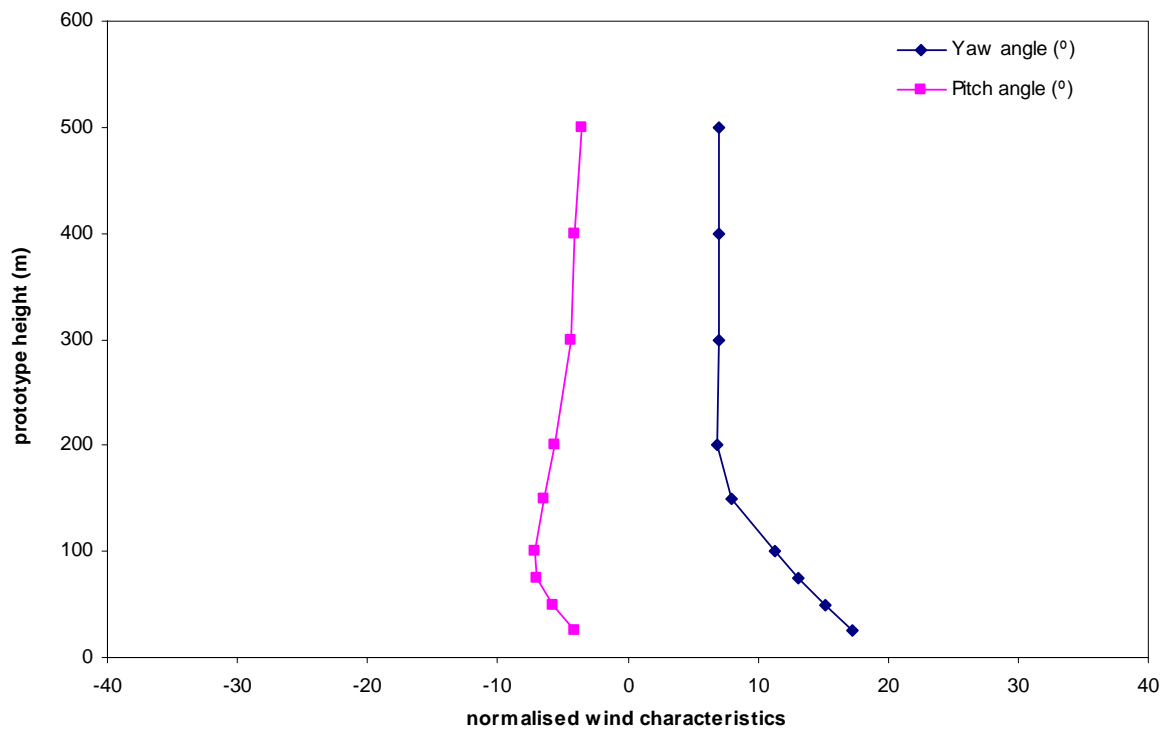

Figure 11b: Mean wind direction, Tsuen Wan, 90°

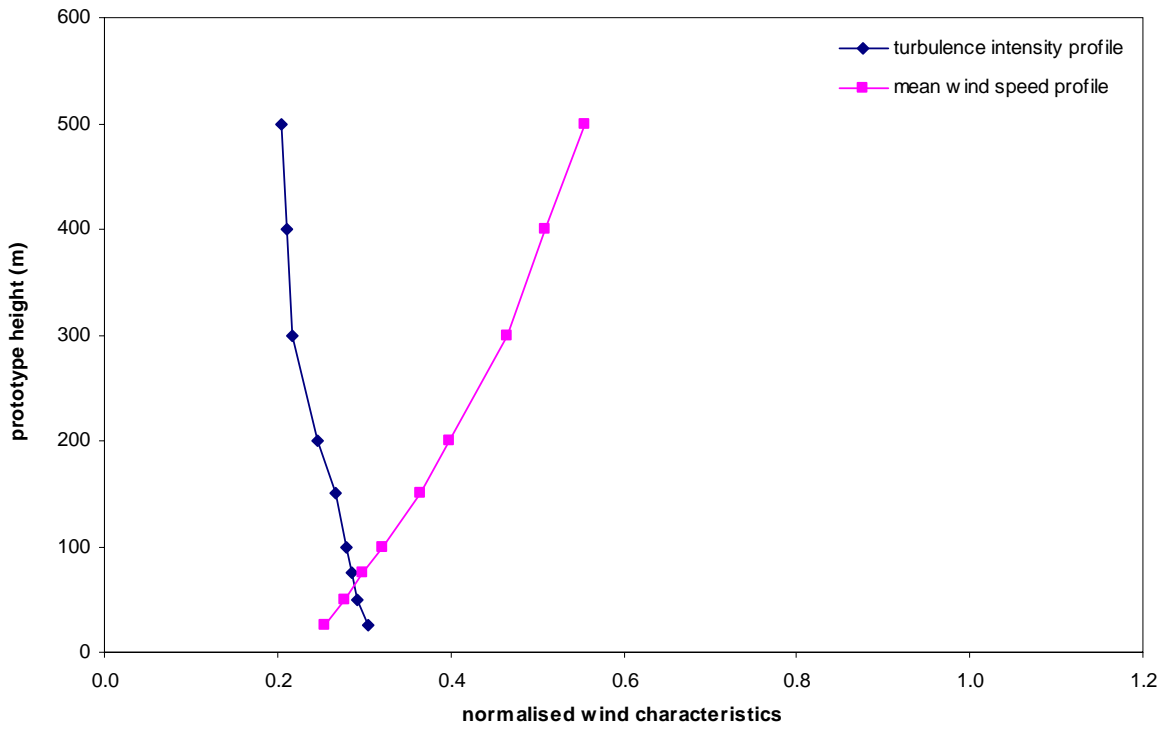

Figure 12a: Wind characteristics, Tsuen Wan, 112.5°

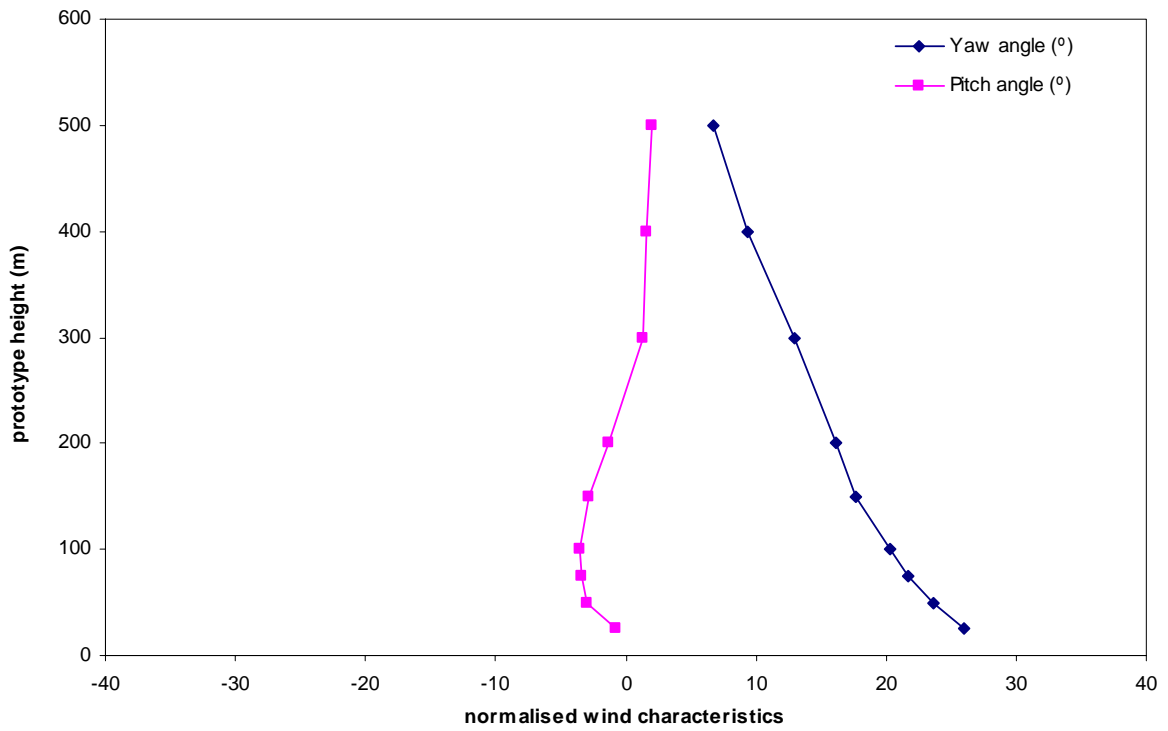

Figure 12b: Mean wind direction, Tsuen Wan, 112.5°

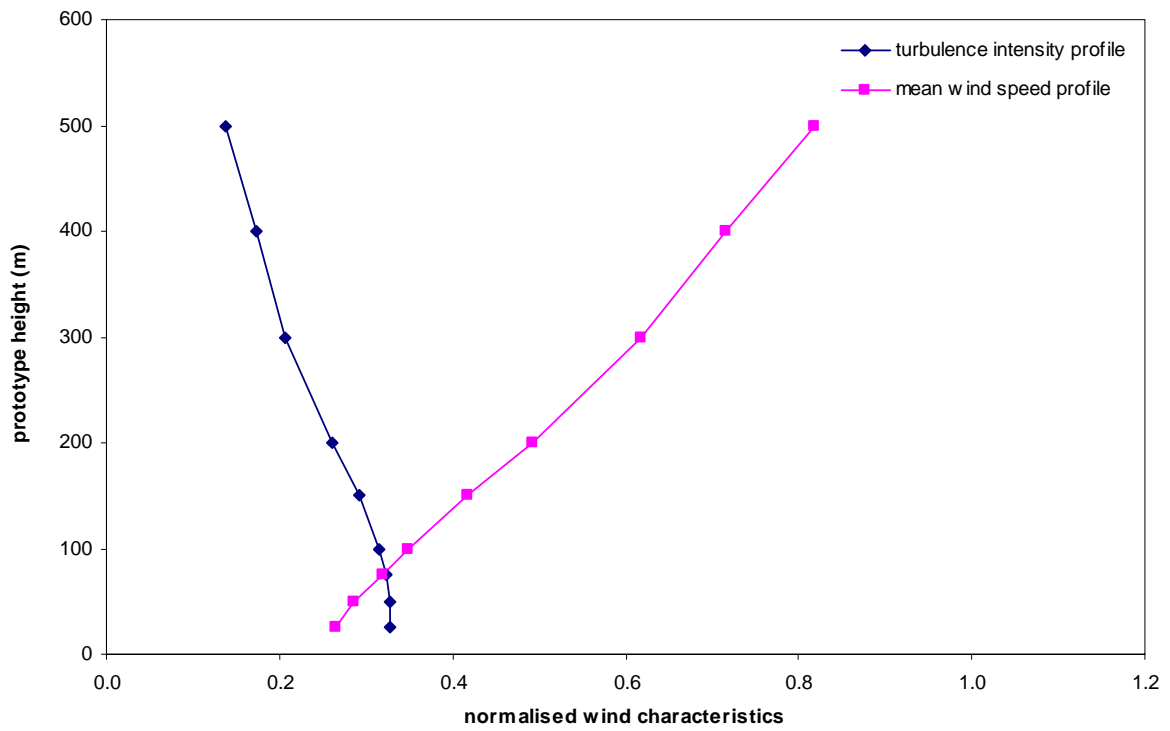

Figure 13a: Wind characteristics, Tsuen Wan, 135°

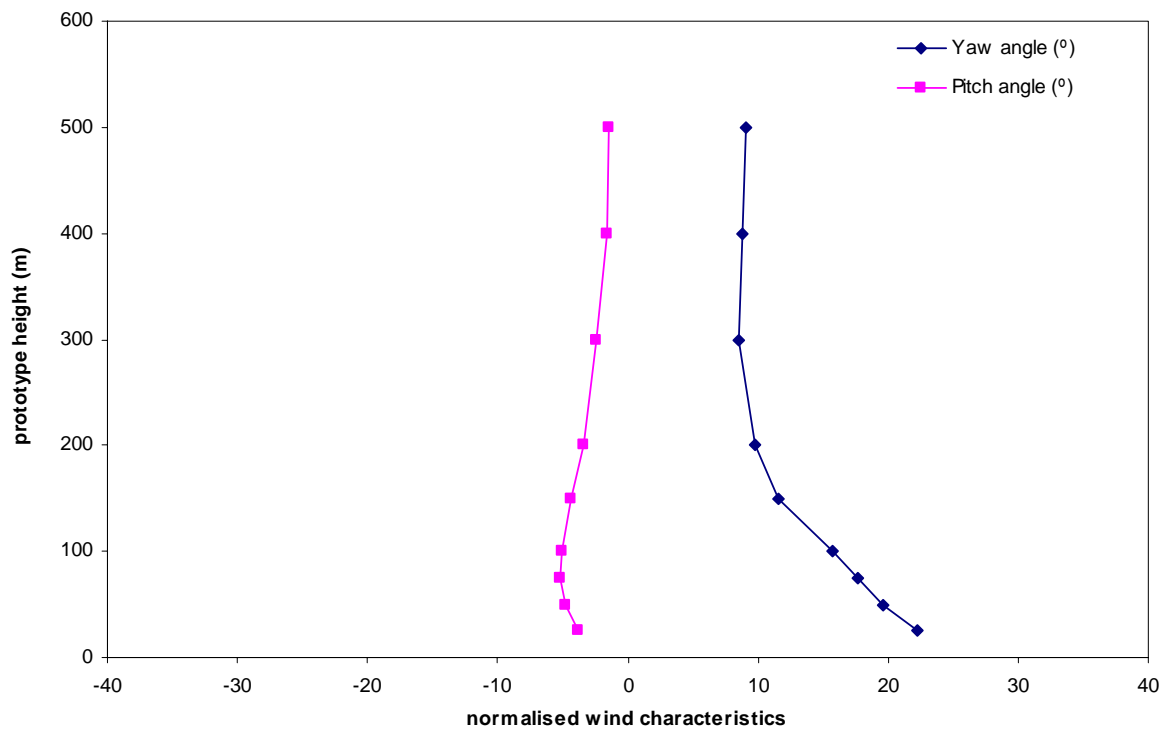

Figure 13b: Mean wind direction, Tsuen Wan, 135°

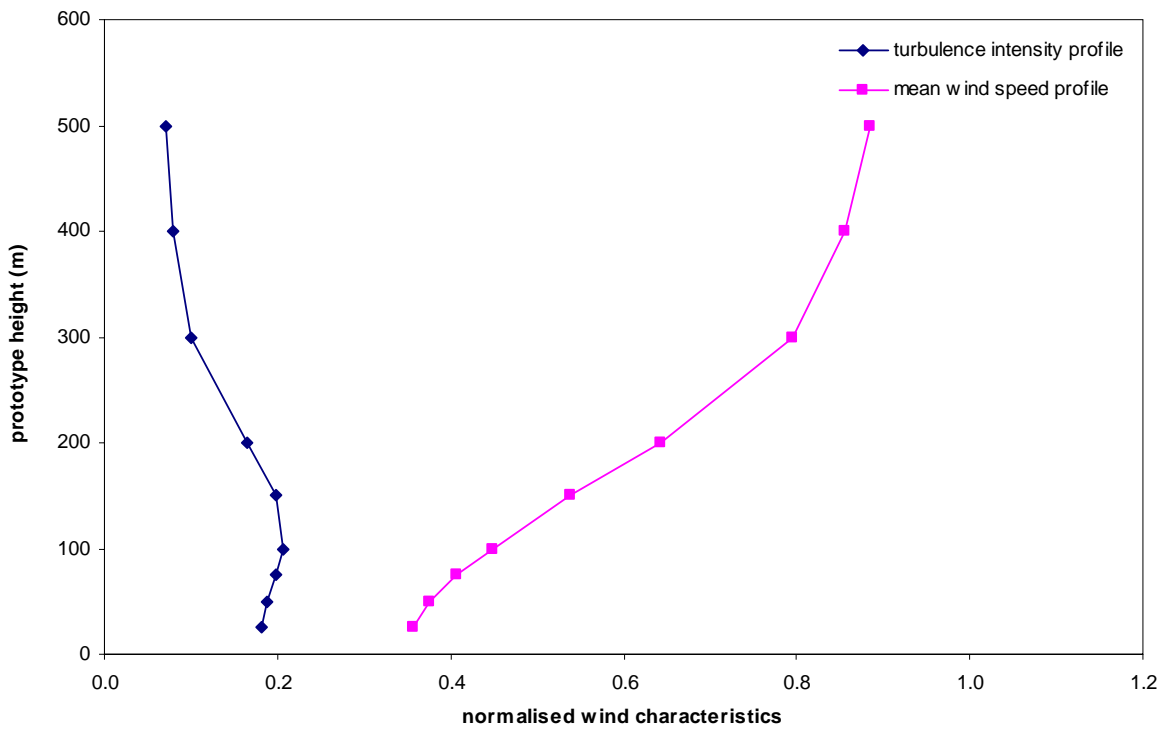

Figure 14a: Wind characteristics, Tsuen Wan, 157.5°

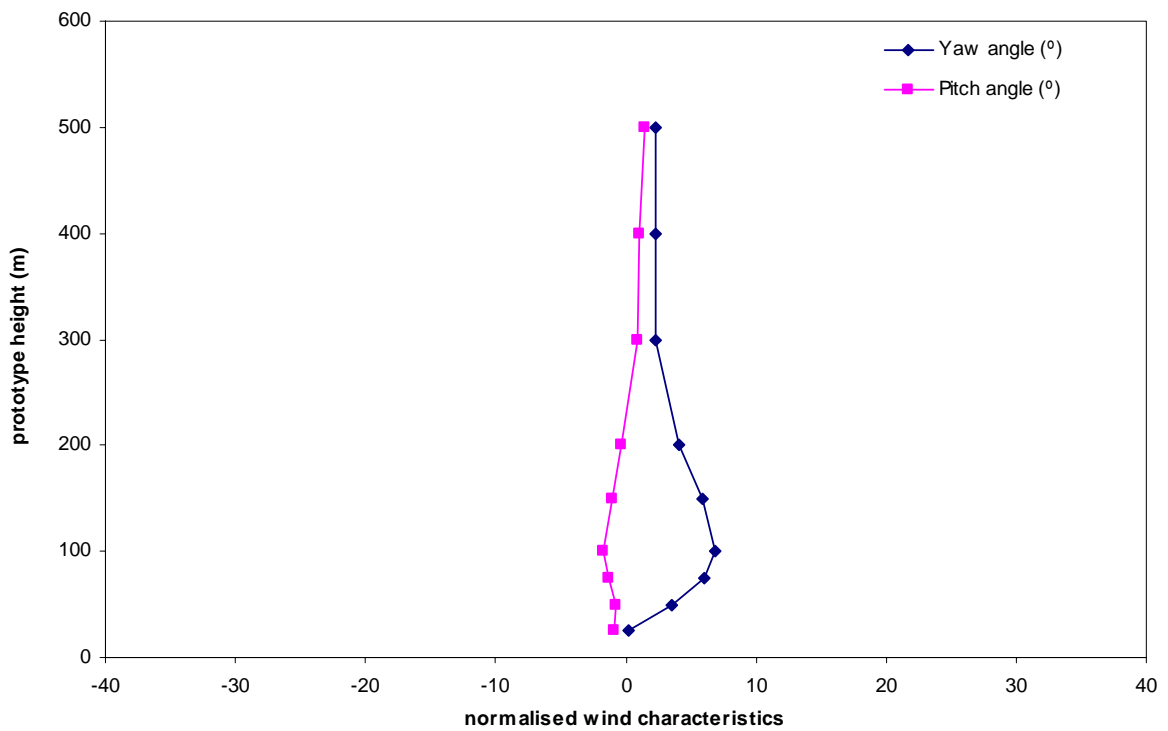

Figure 14b: Mean wind direction, Tsuen Wan, 157.5°

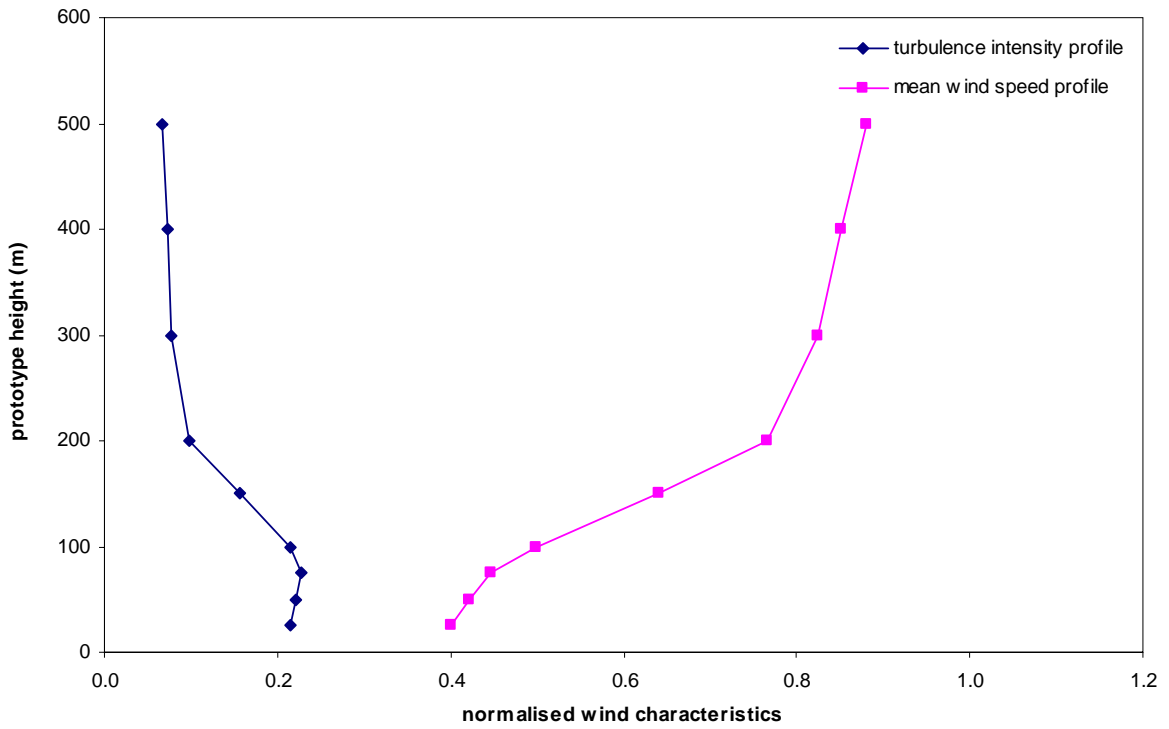

Figure 15a: Wind characteristics, Tsuen Wan, 180°

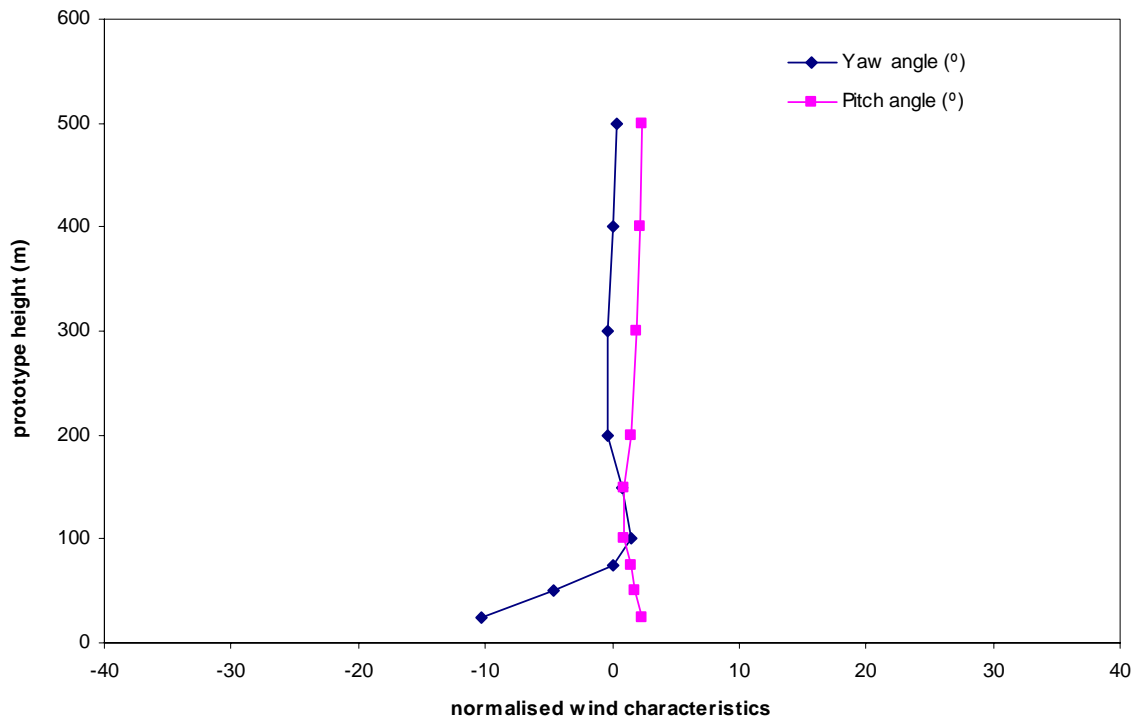

Figure 15b: Mean wind direction, Tsuen Wan, 180°

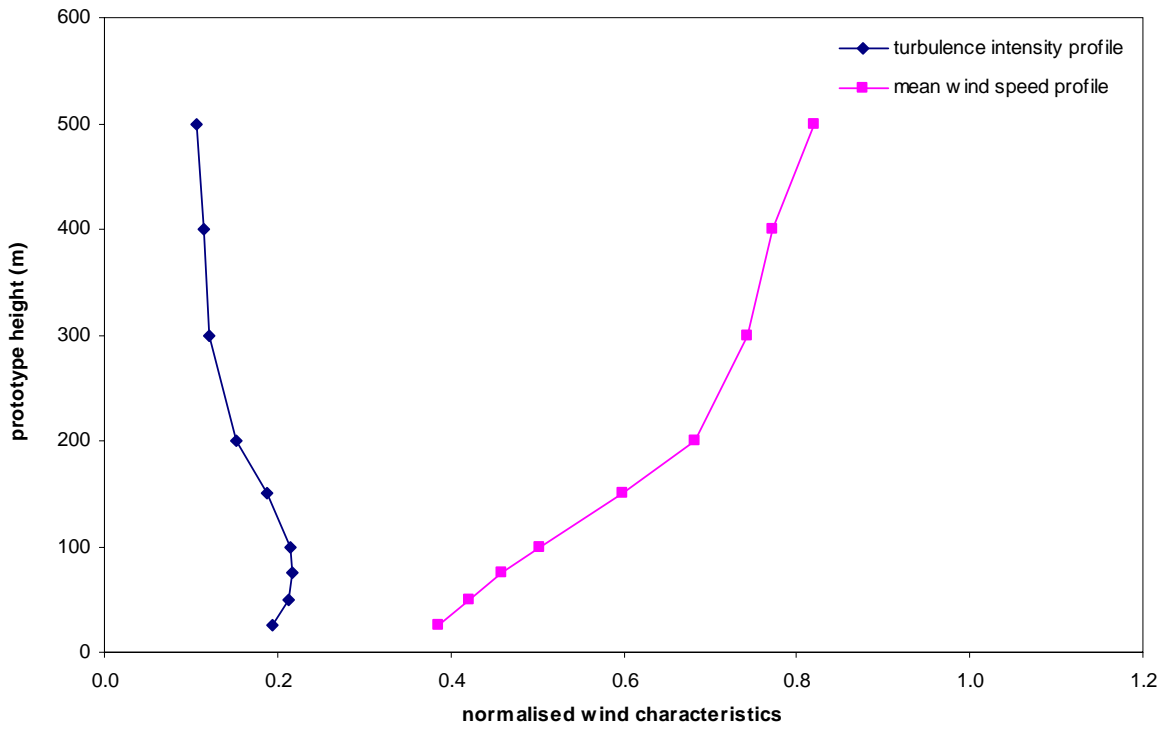

Figure 16a: Wind characteristics, Tsuen Wan, 202.5°

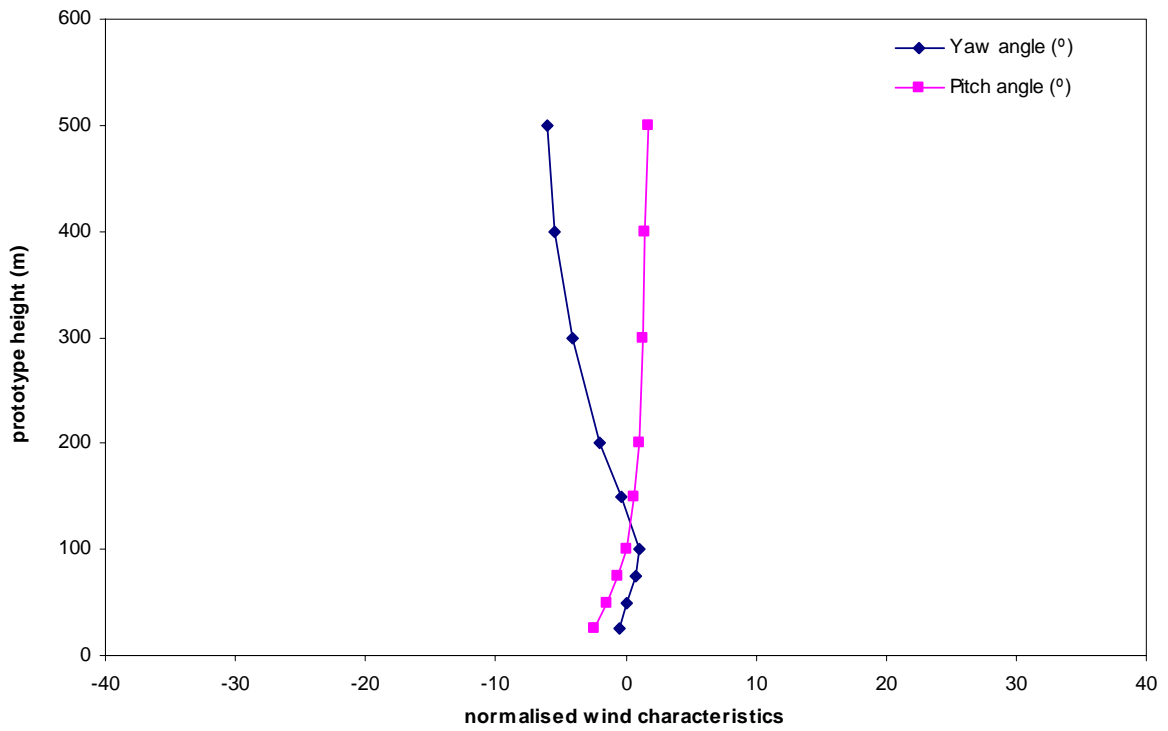

Figure 16b: Mean wind direction, Tsuen Wan, 202.5°

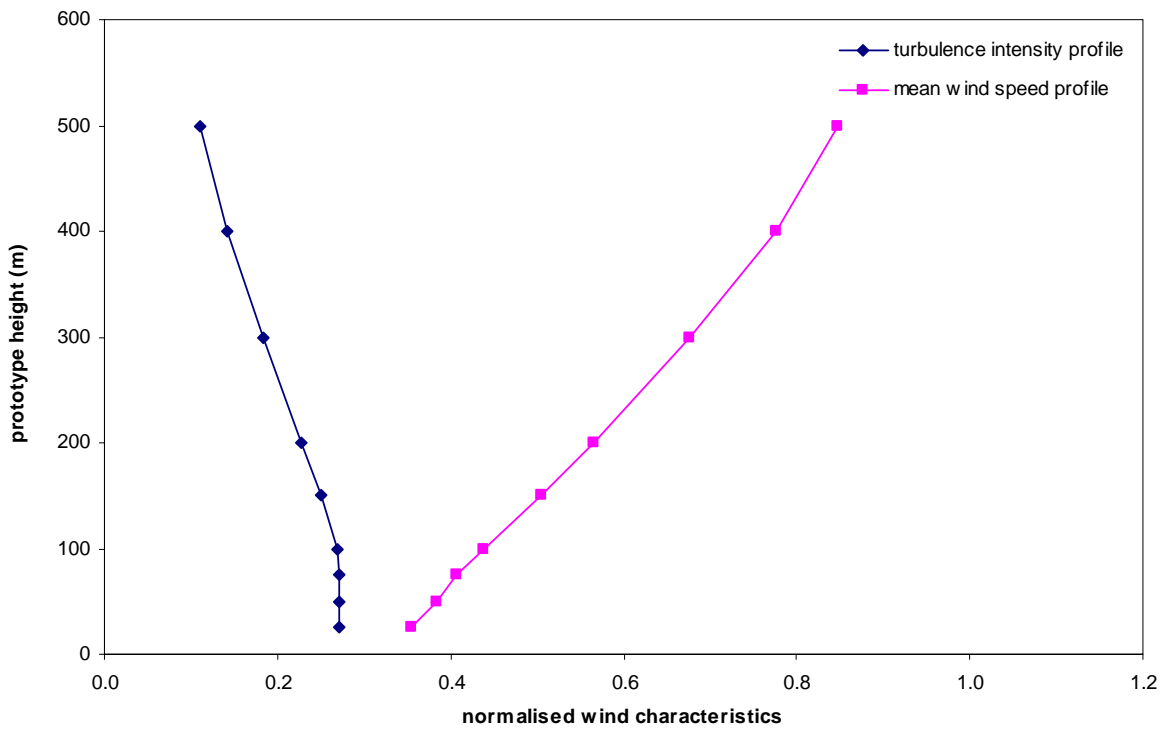

Figure 17a: Wind characteristics, Tsuen Wan, 225°

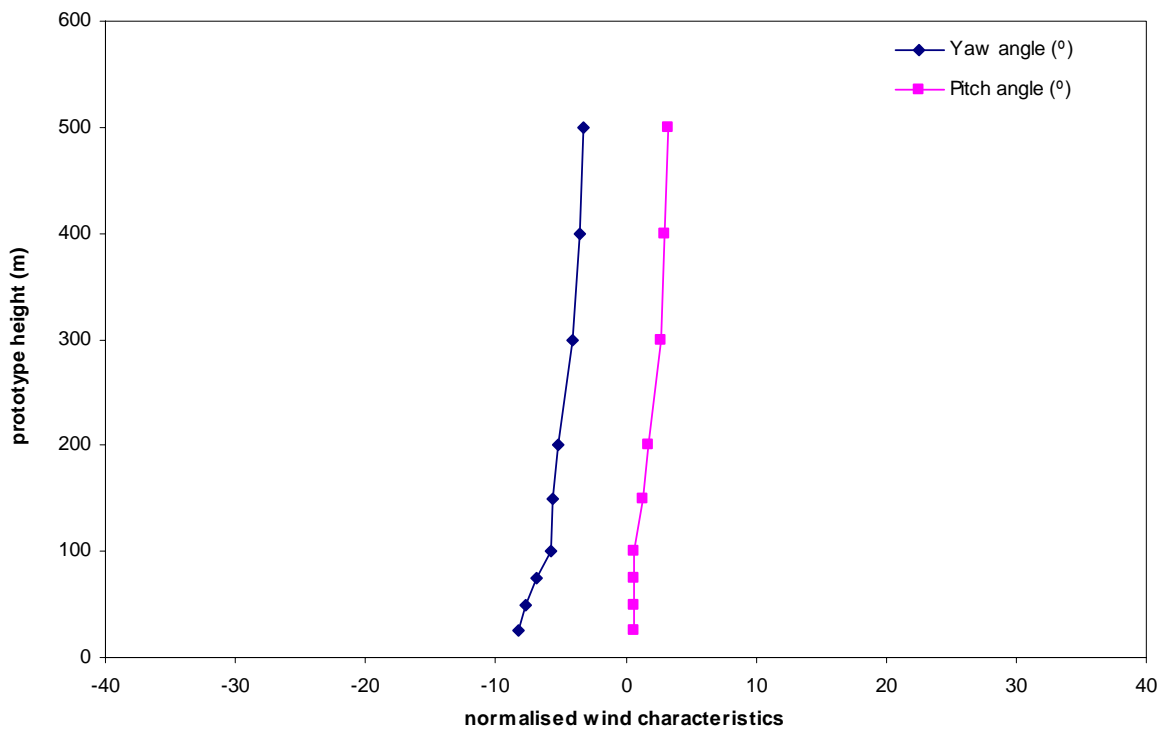

Figure 17b: Mean wind direction, Tsuen Wan, 225°

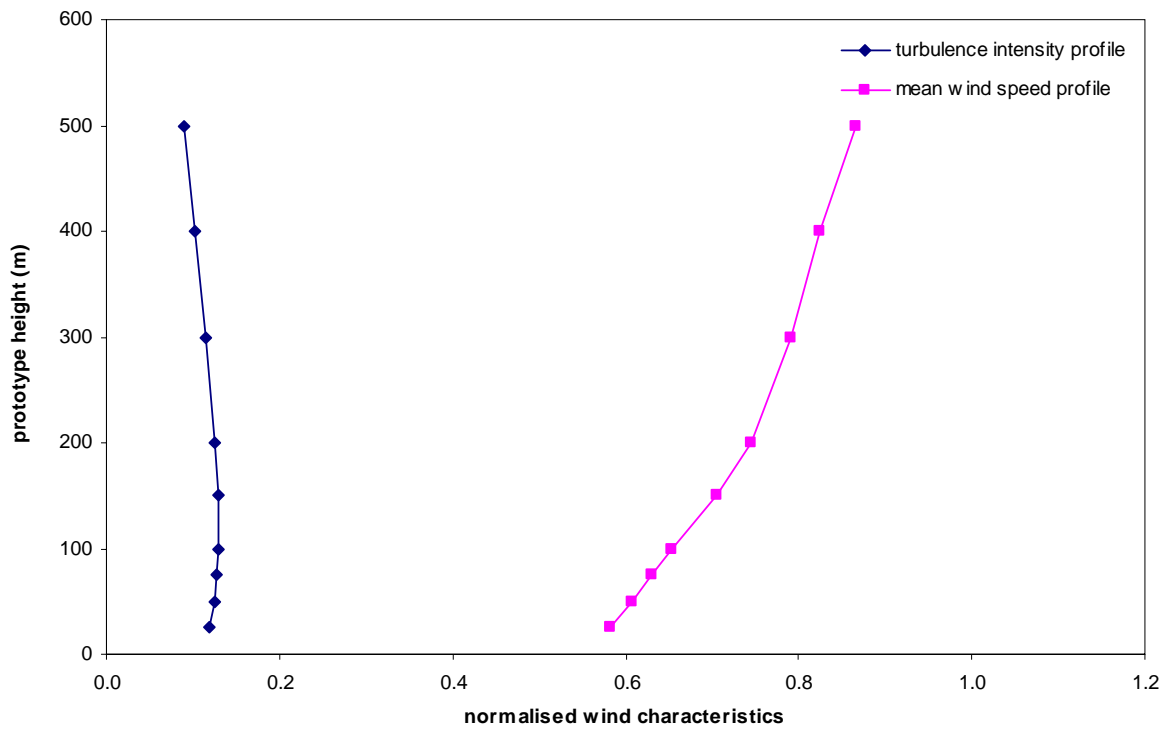

Figure 18a: Wind characteristics, Tsuen Wan, 247.5°

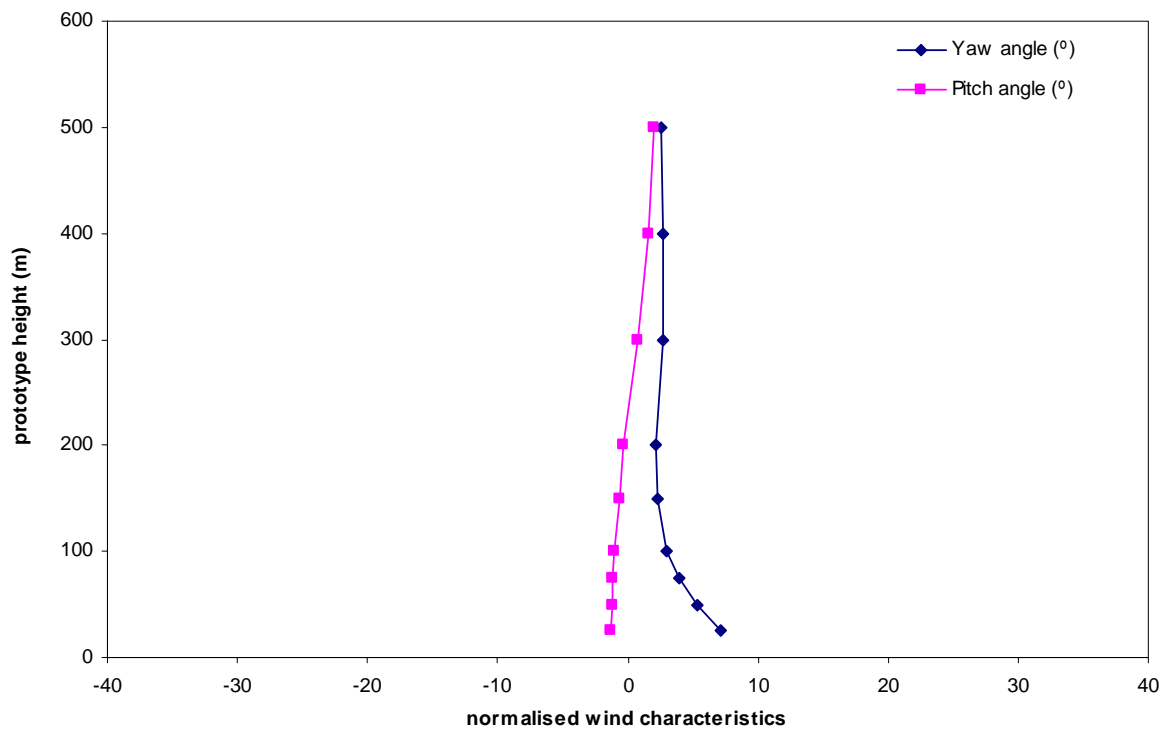

Figure 18b: Mean wind direction, Tsuen Wan, 247.5°

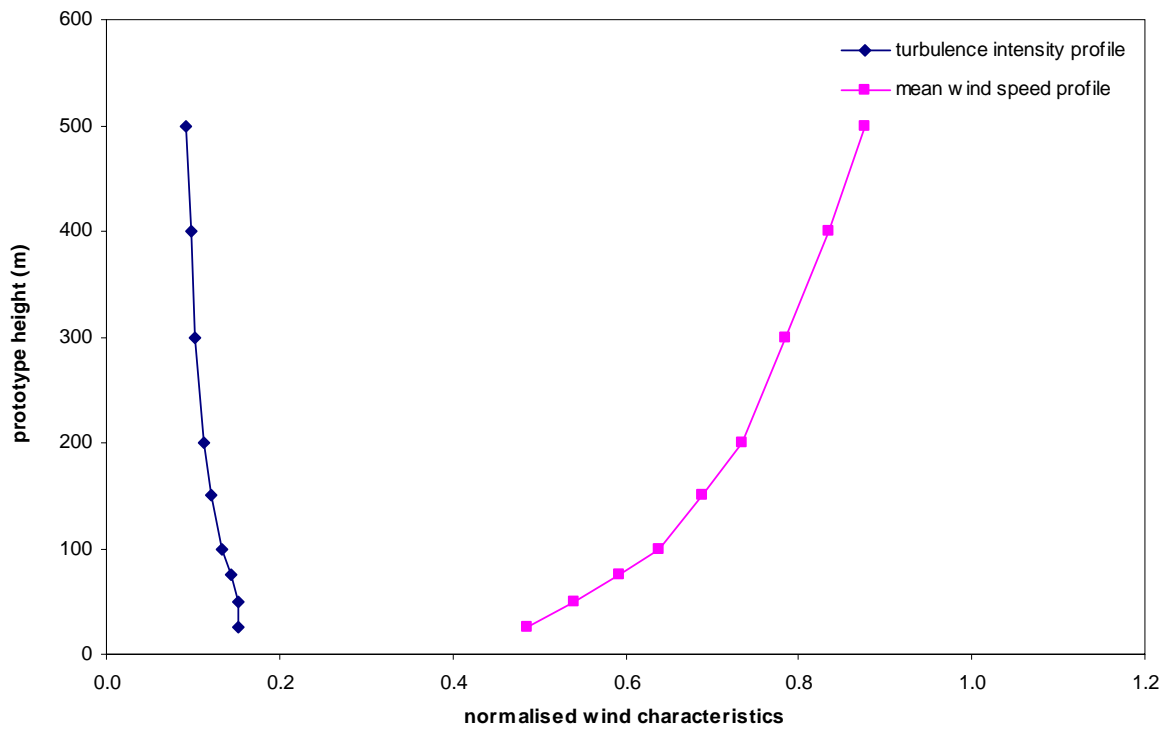

Figure 19a: Wind characteristics, Tsuen Wan, 270°

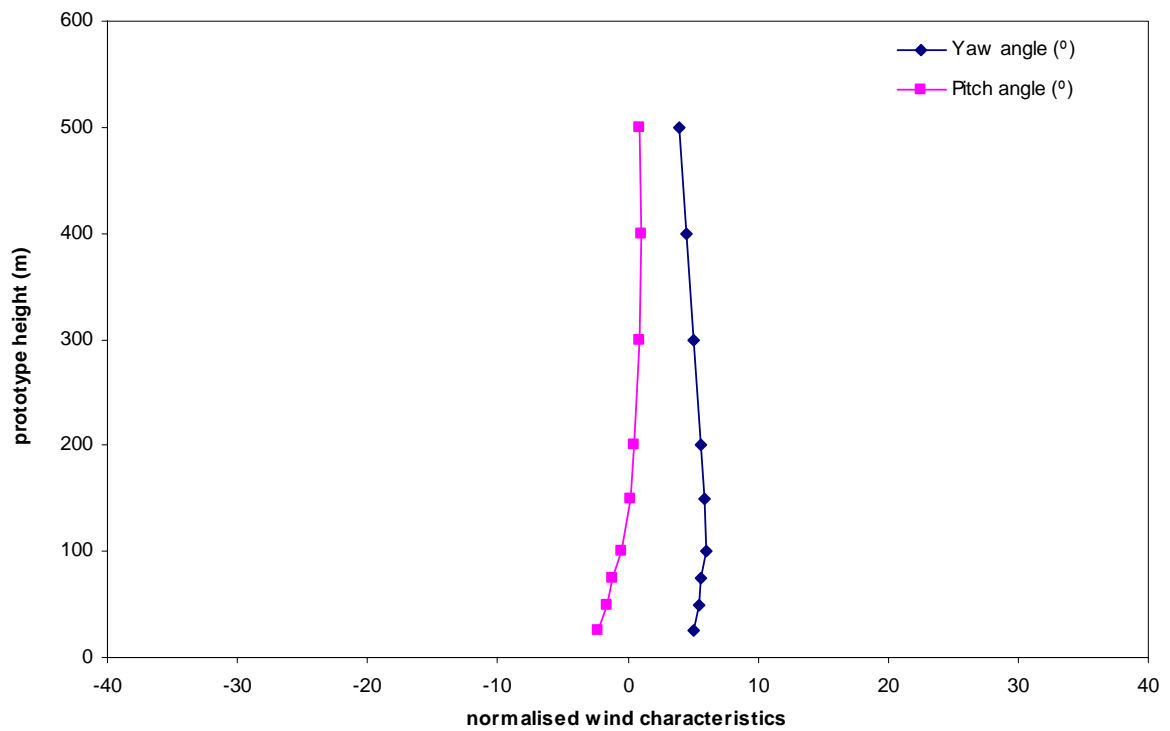

Figure 19b: Mean wind direction, Tsuen Wan, 270°

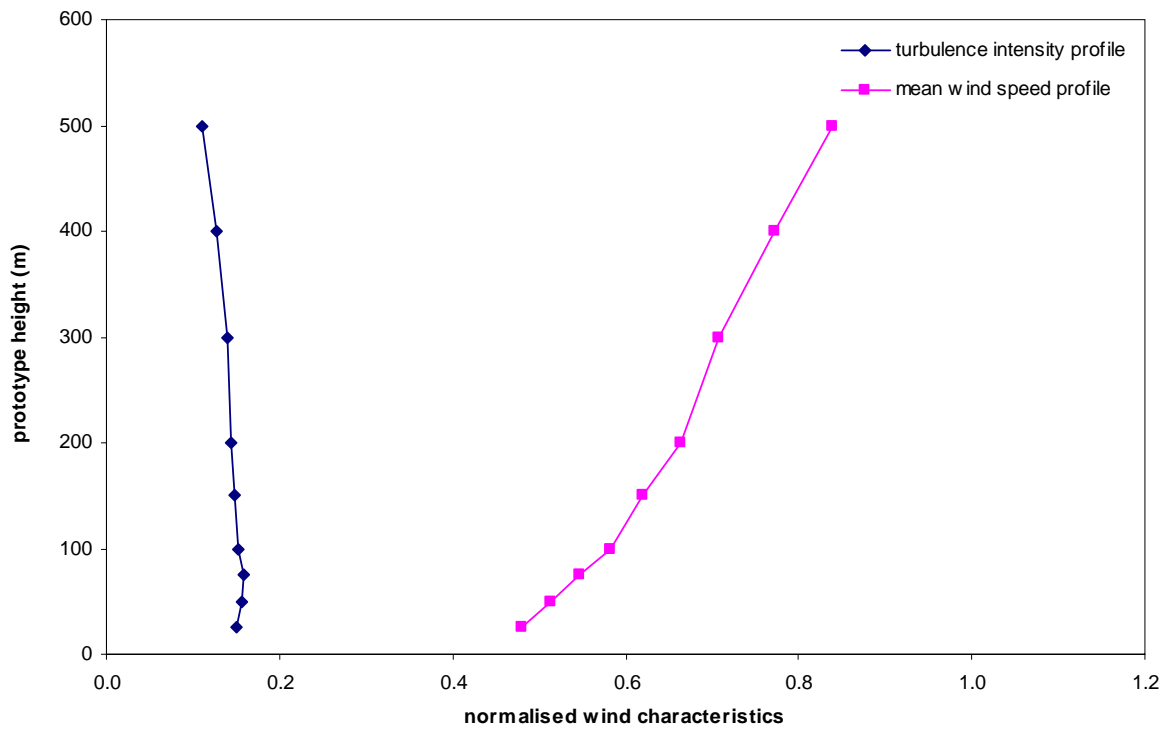

Figure 20a: Wind characteristics, Tsuen Wan, 292.5°

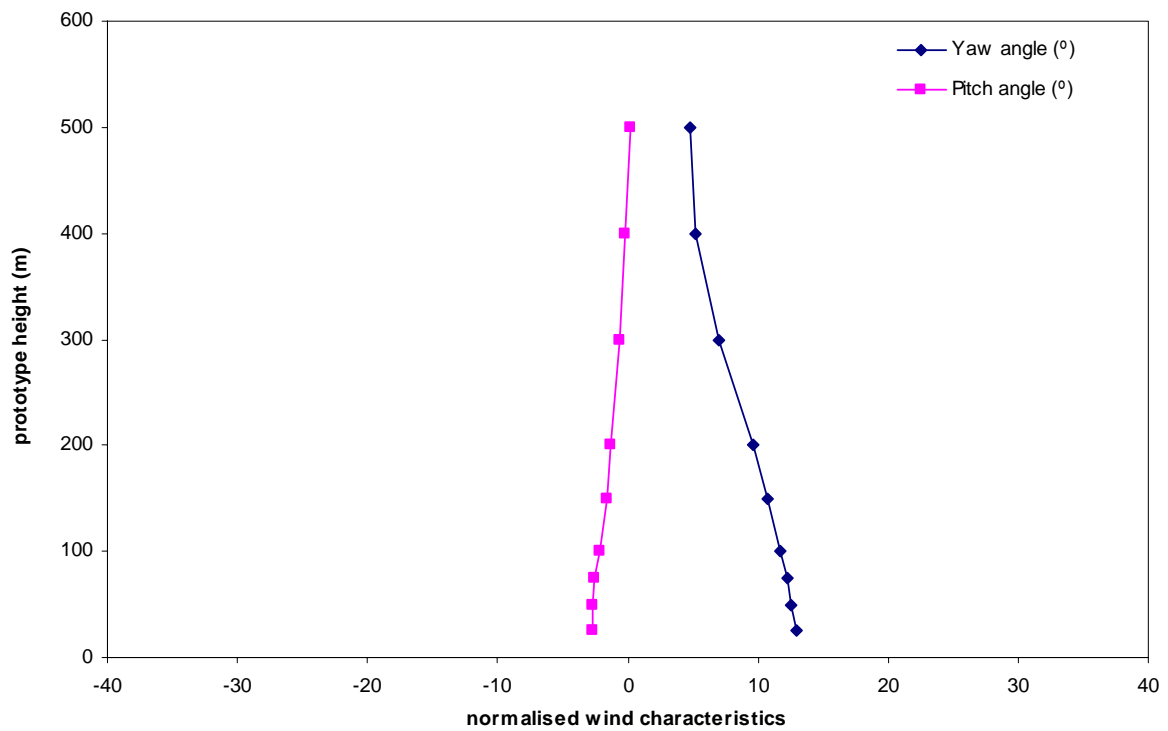

Figure 20b: Mean wind direction, Tsuen Wan, 292.5°

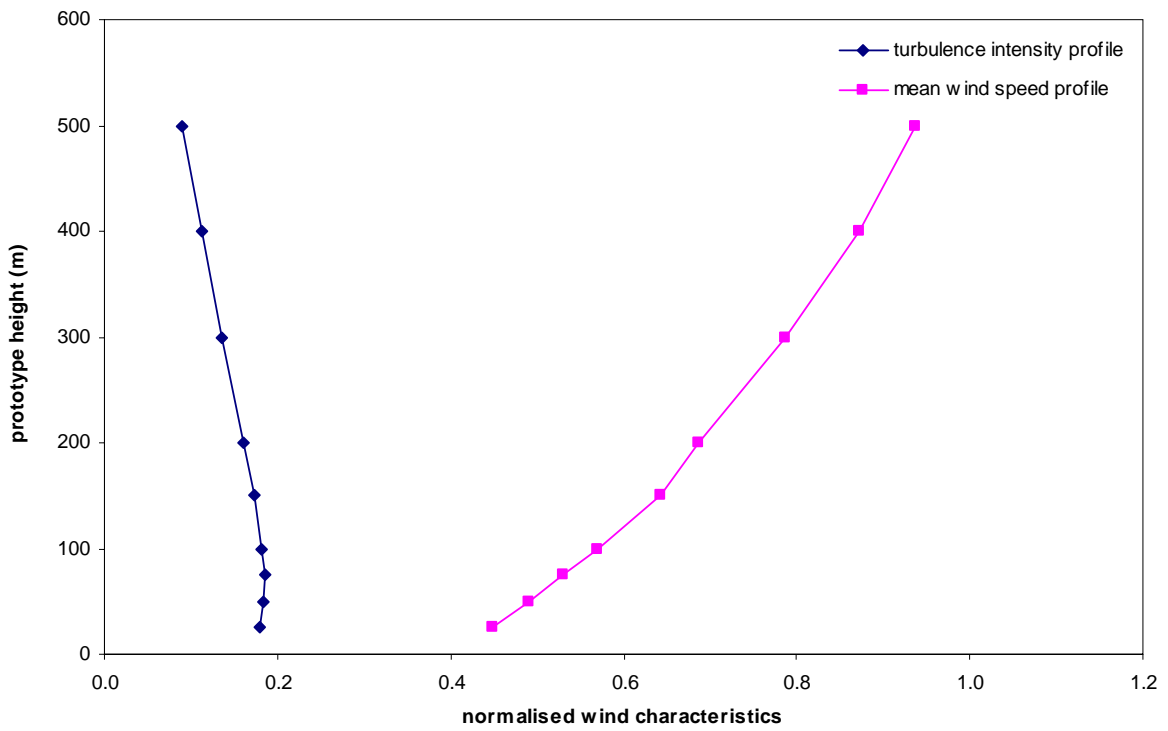

Figure 21a: Wind characteristics, Tsuen Wan, 315°

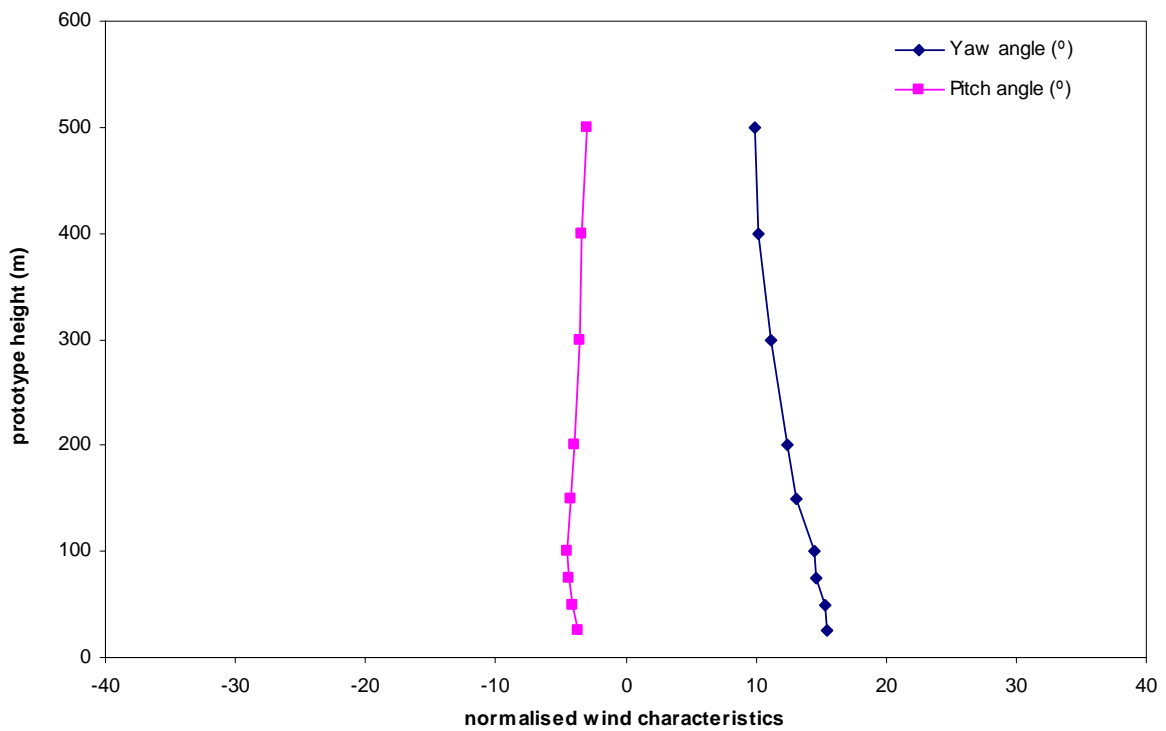

Figure 21b: Mean wind direction, Tsuen Wan, 315°

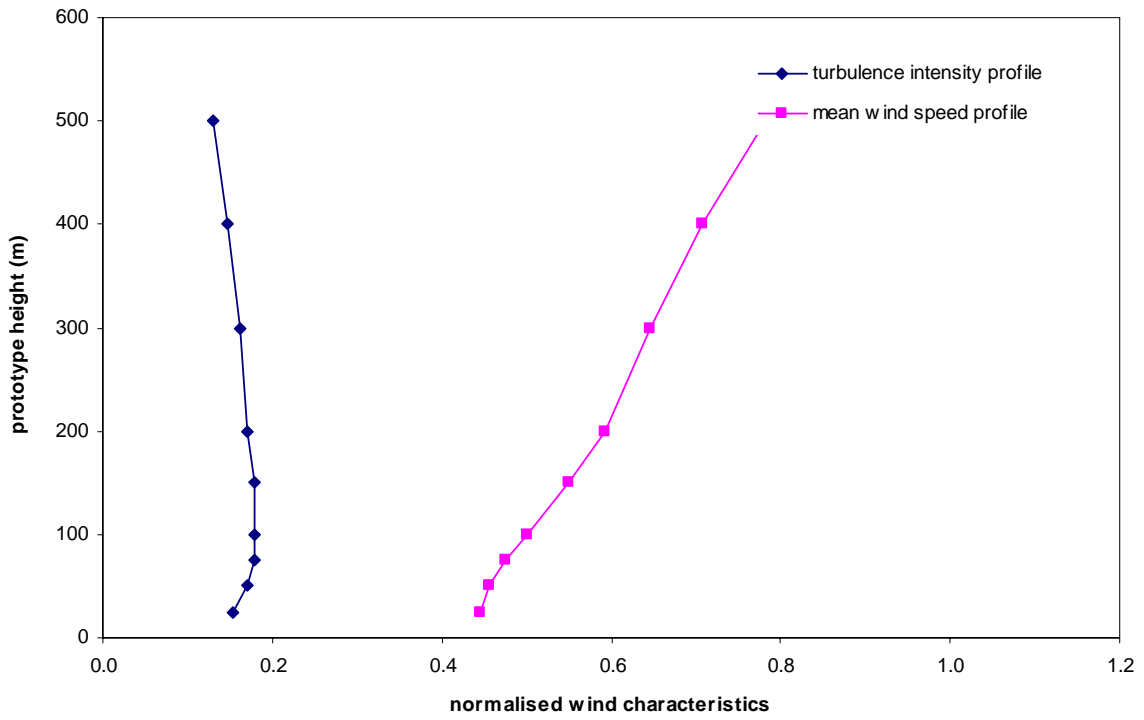

Figure 22a: Wind characteristics, Tsuen Wan, 337.5°

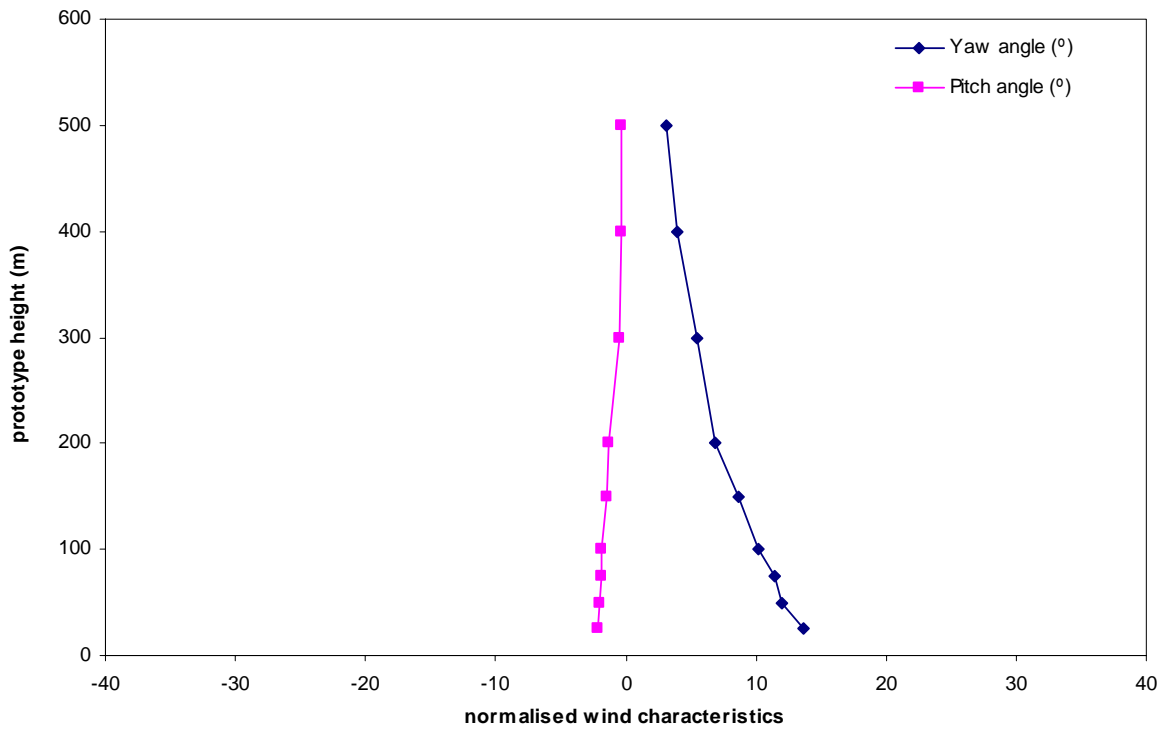

Figure 22b: Mean wind direction, Tsuen Wan, 337.5°

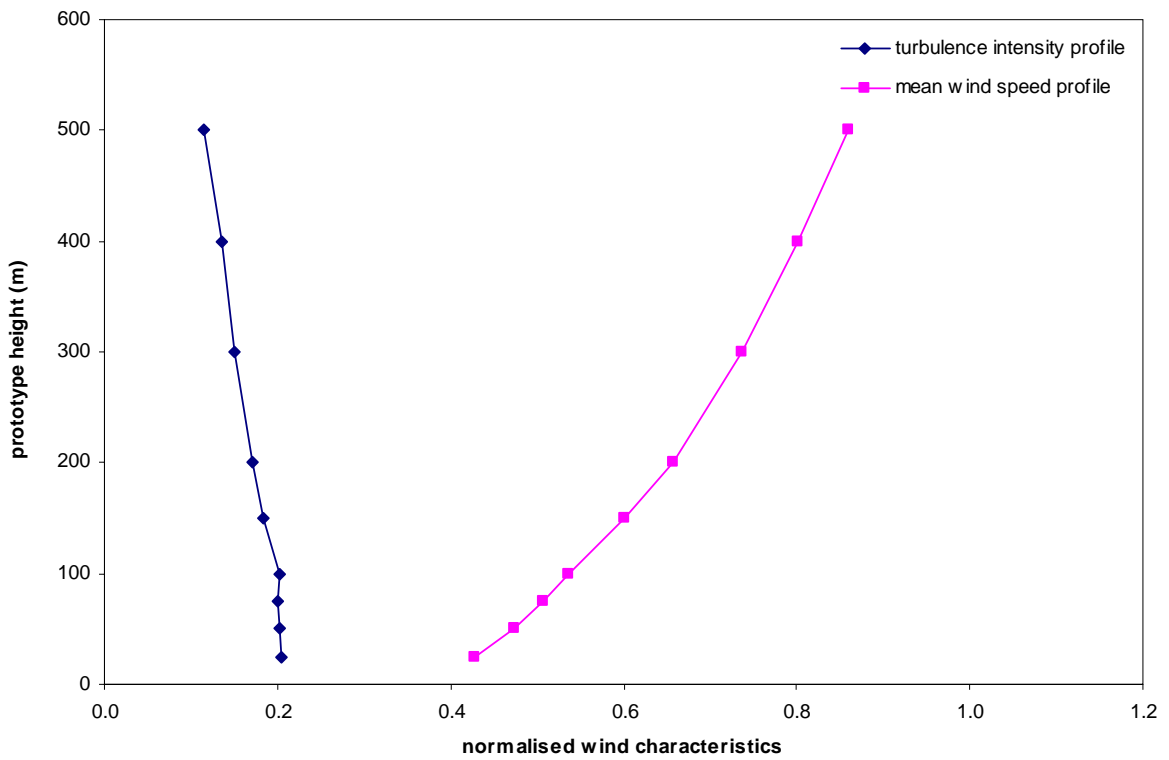

Figure 23a: Wind characteristics, Tsuen Wan, 360°

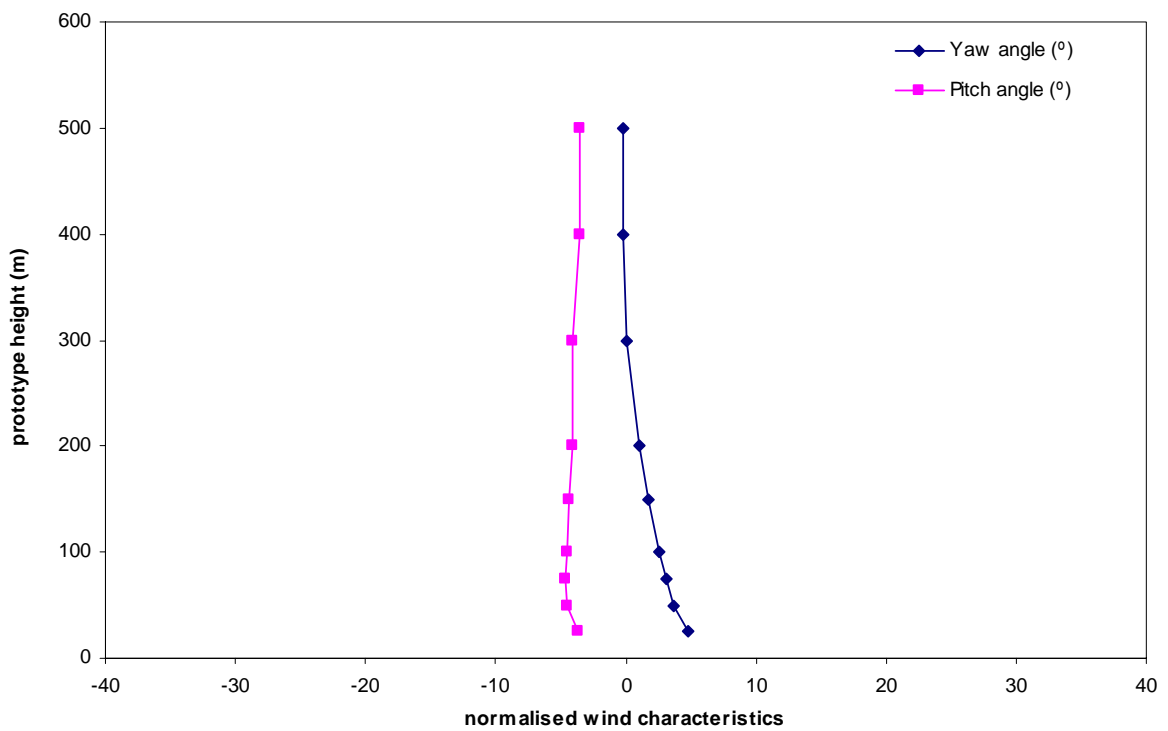

Figure 23b: Mean wind direction, Tsuen Wan, 360°

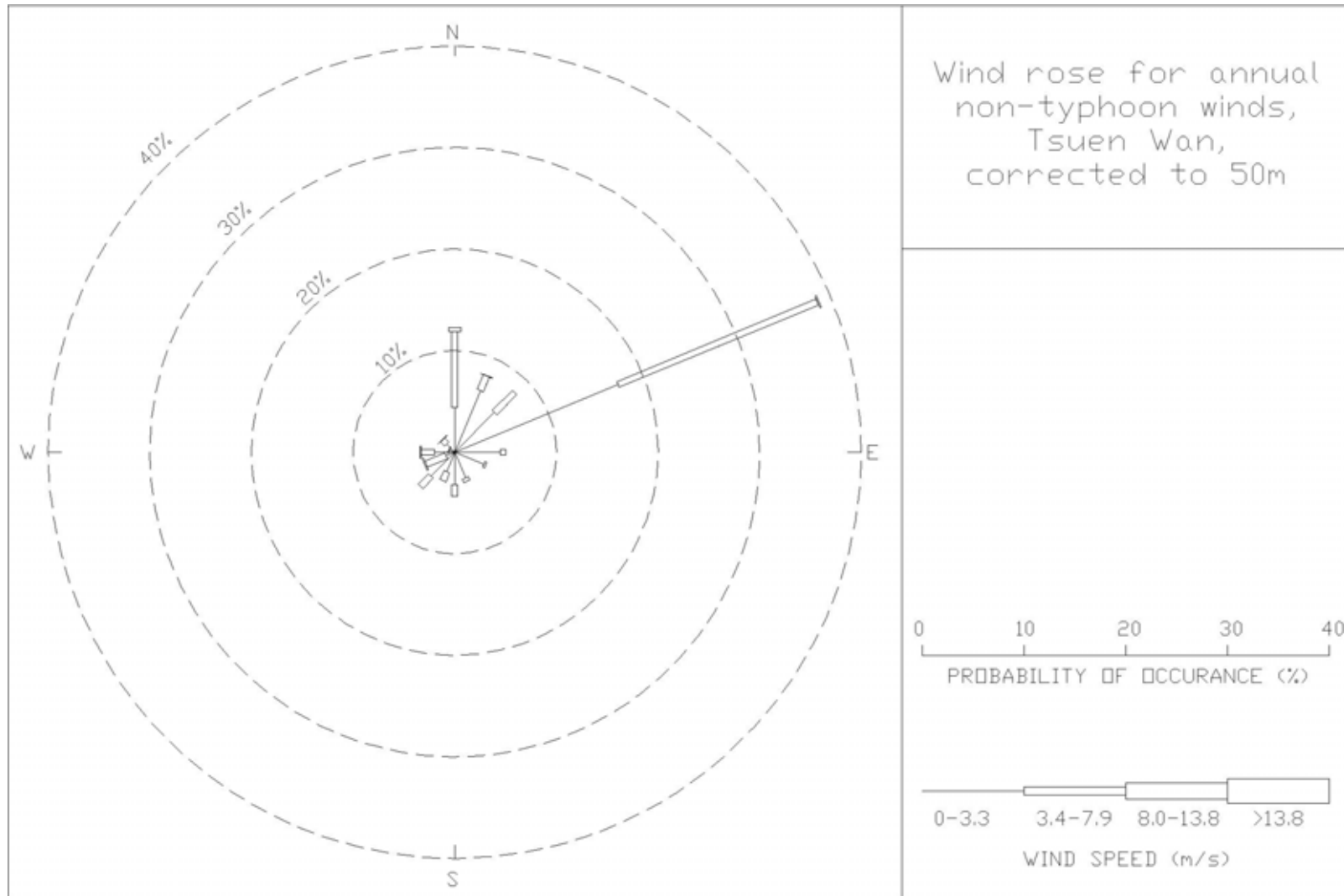

Figure 24: Wind rose for annual, non-typhoon winds for Tsuen Wan, existing configuration, corrected to 50m

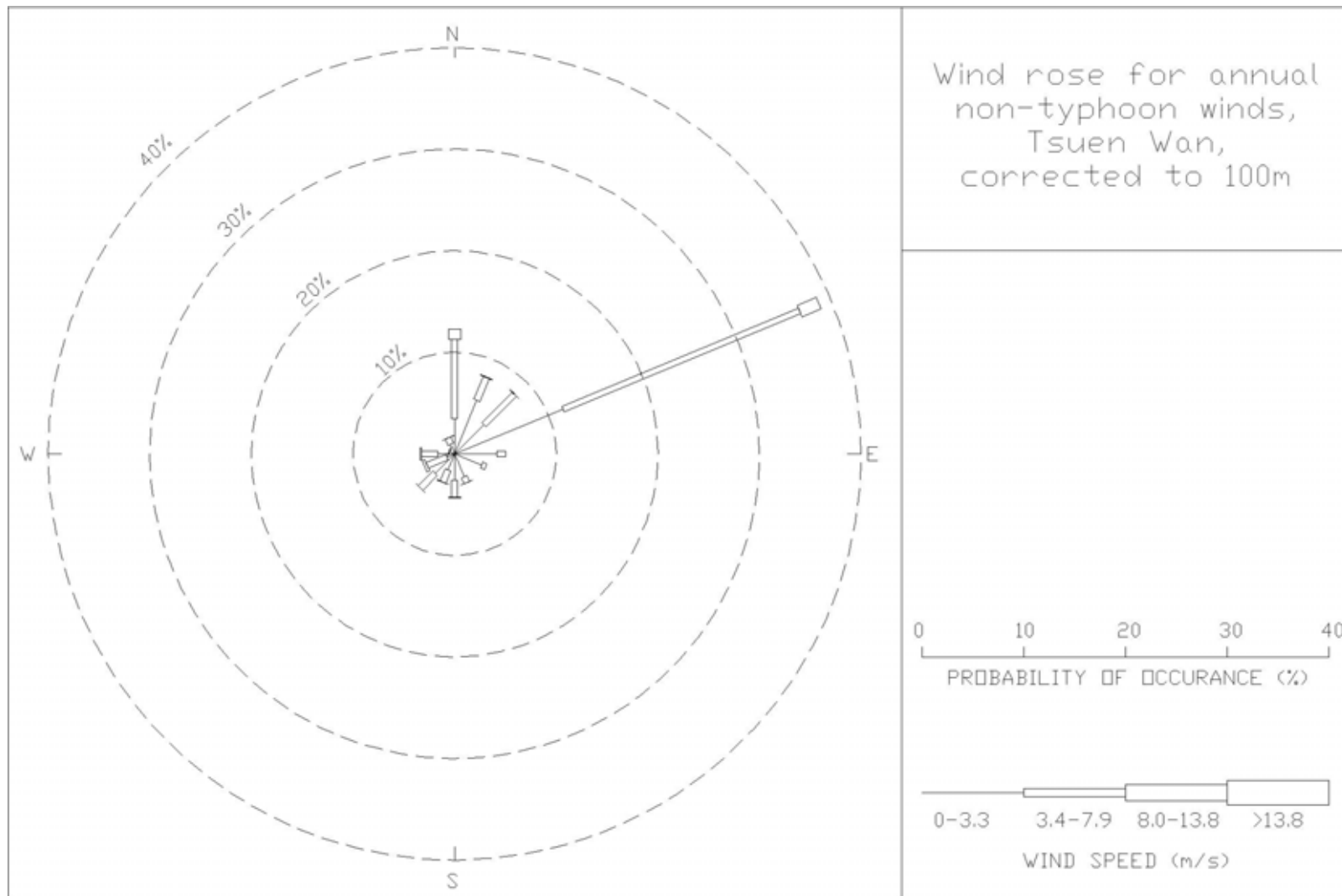

Figure 25: Wind rose for annual, non-typhoon winds for Tsuen Wan, existing configuration, corrected to 100m

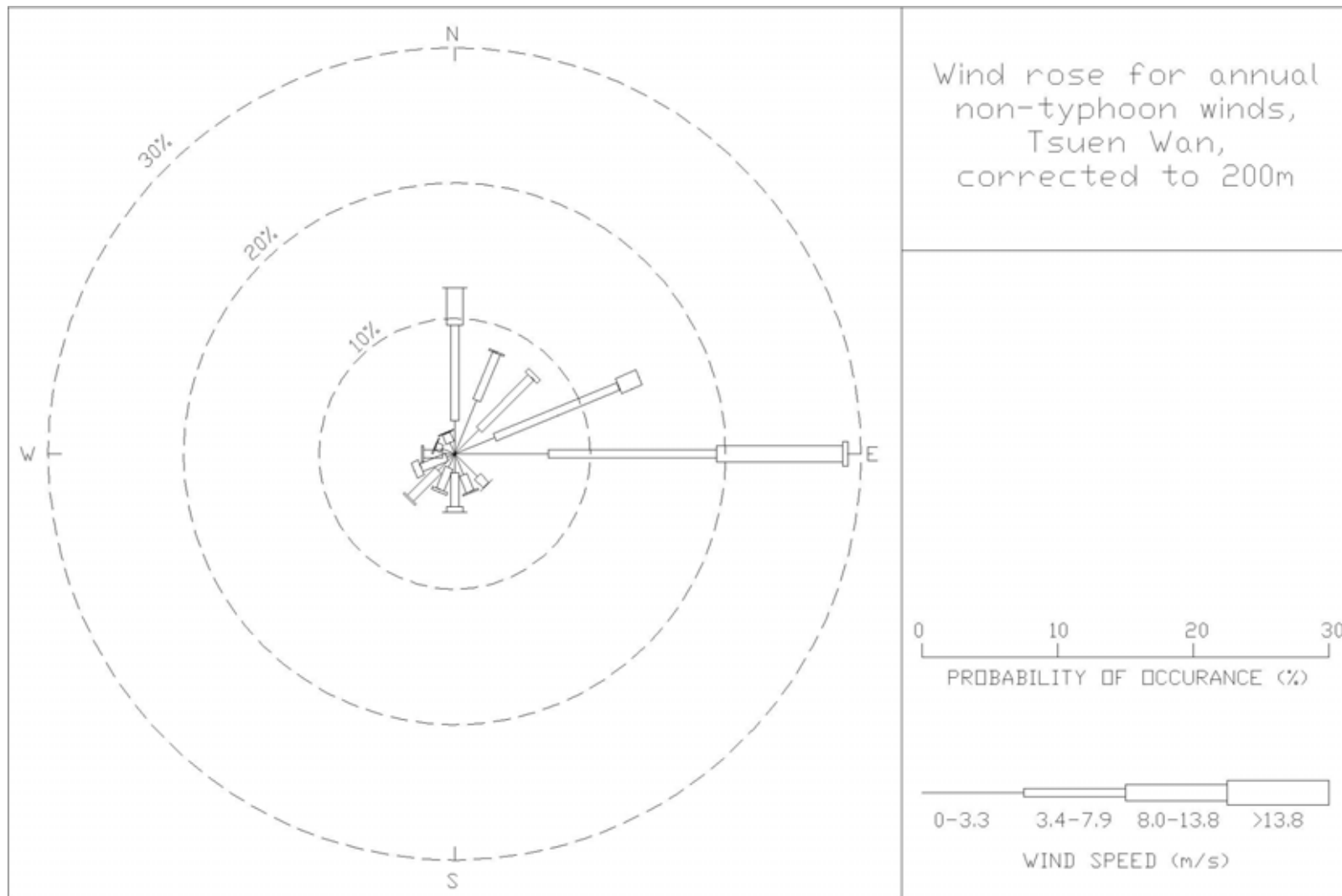

Figure 26: Wind rose for annual, non-typhoon winds for Tsuen Wan, existing configuration, corrected to 200m

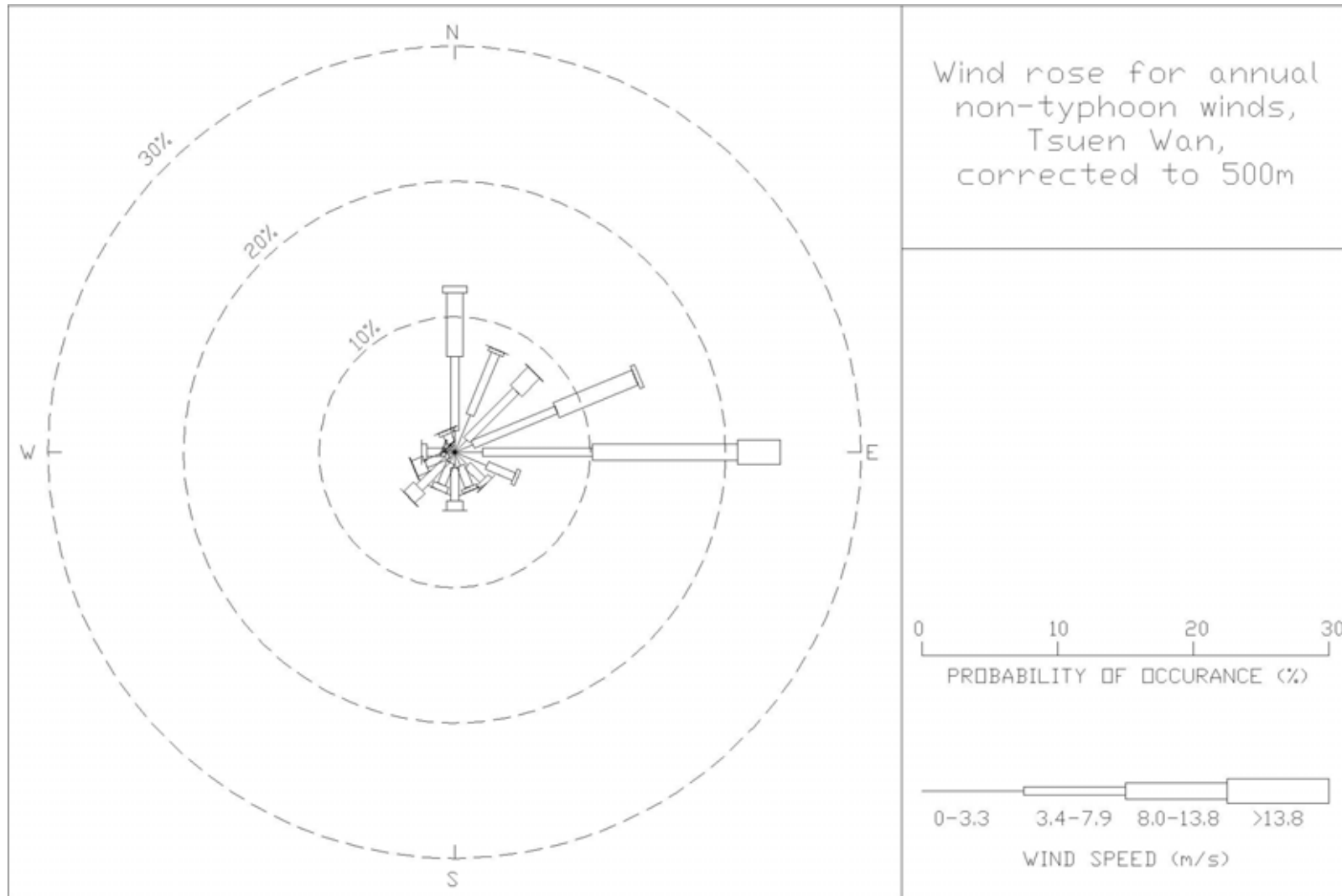

Figure 27: Wind rose for annual, non-typhoon winds for Tsuen Wan, existing configuration, corrected to 500m

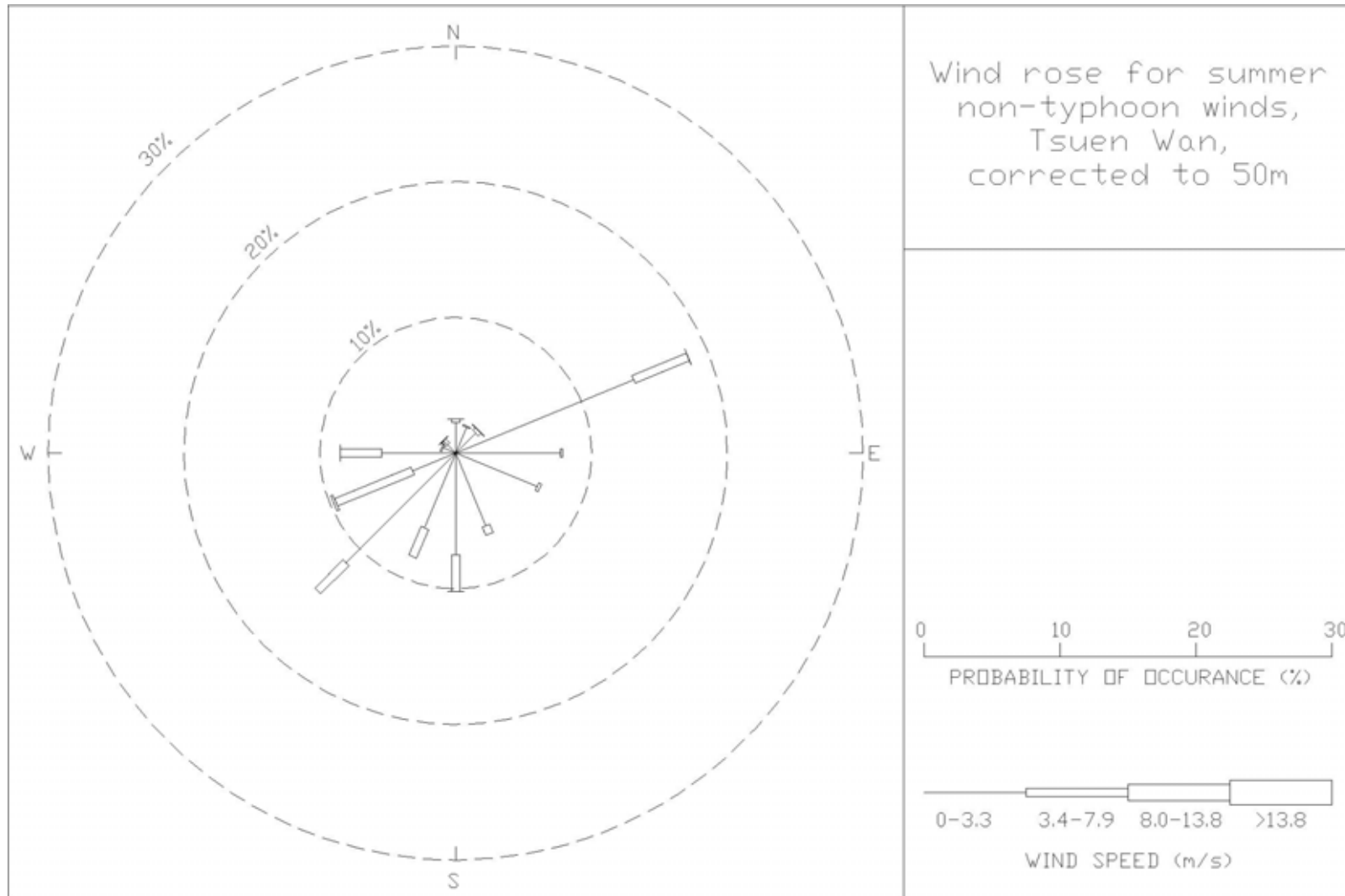

Figure 28: Wind rose for summer, non-typhoon winds for Tsuen Wan, existing configuration, corrected to 50m

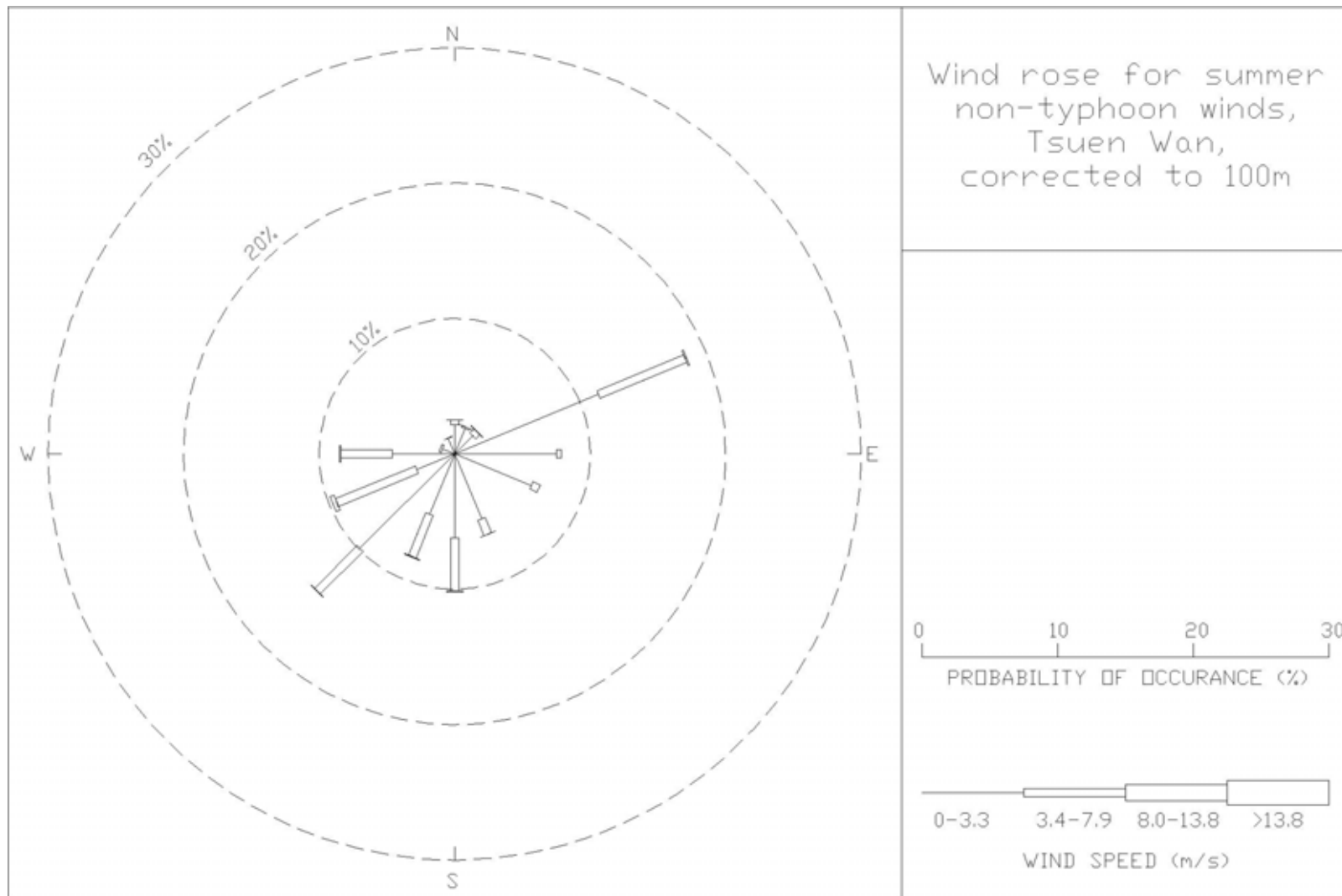

Figure 29: Wind rose for summer, non-typhoon winds for Tsuen Wan, existing configuration, corrected to 100m

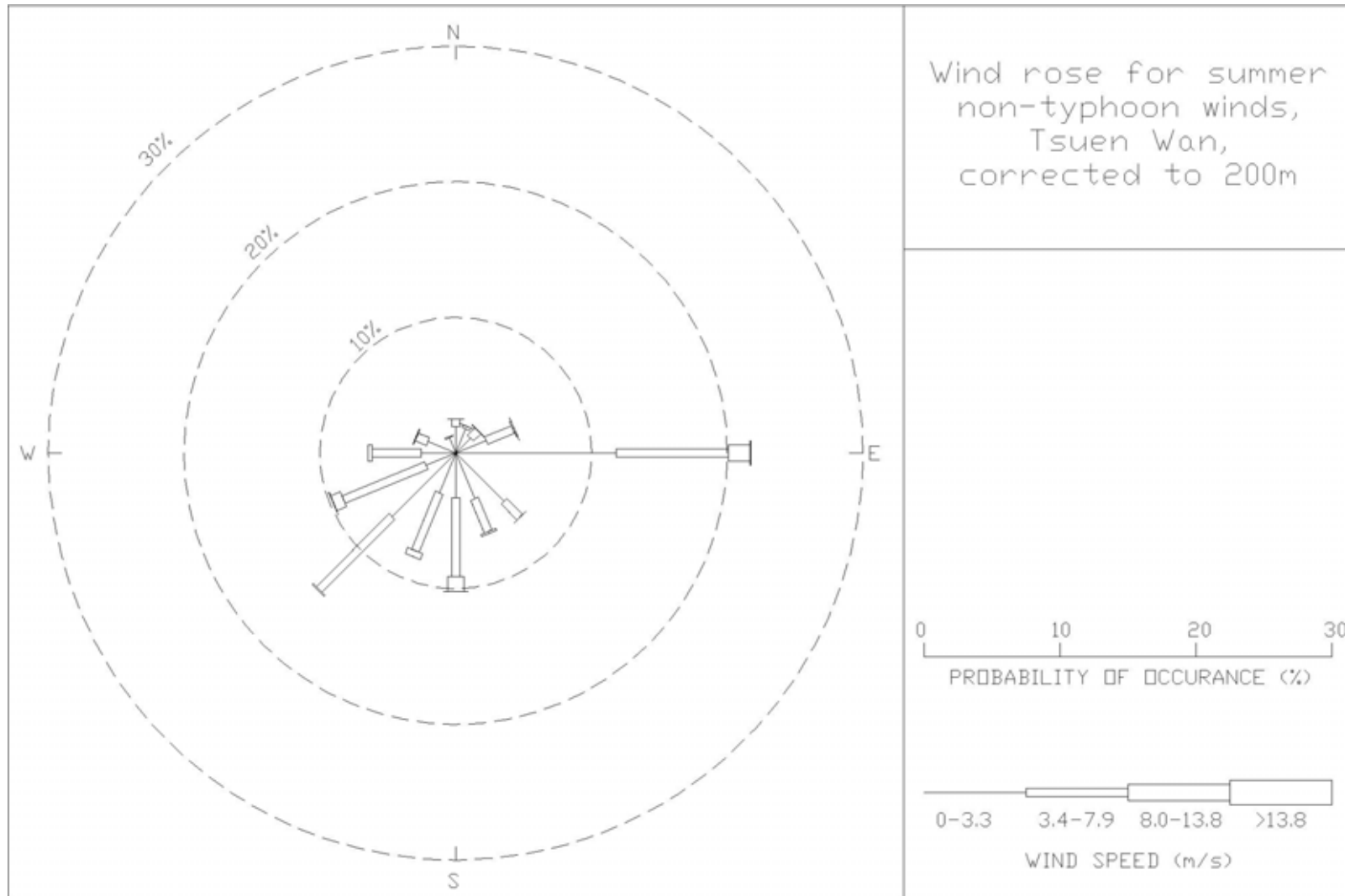

Figure 30: Wind rose for summer, non-typhoon winds for Tsuen Wan, existing configuration, corrected to 200m

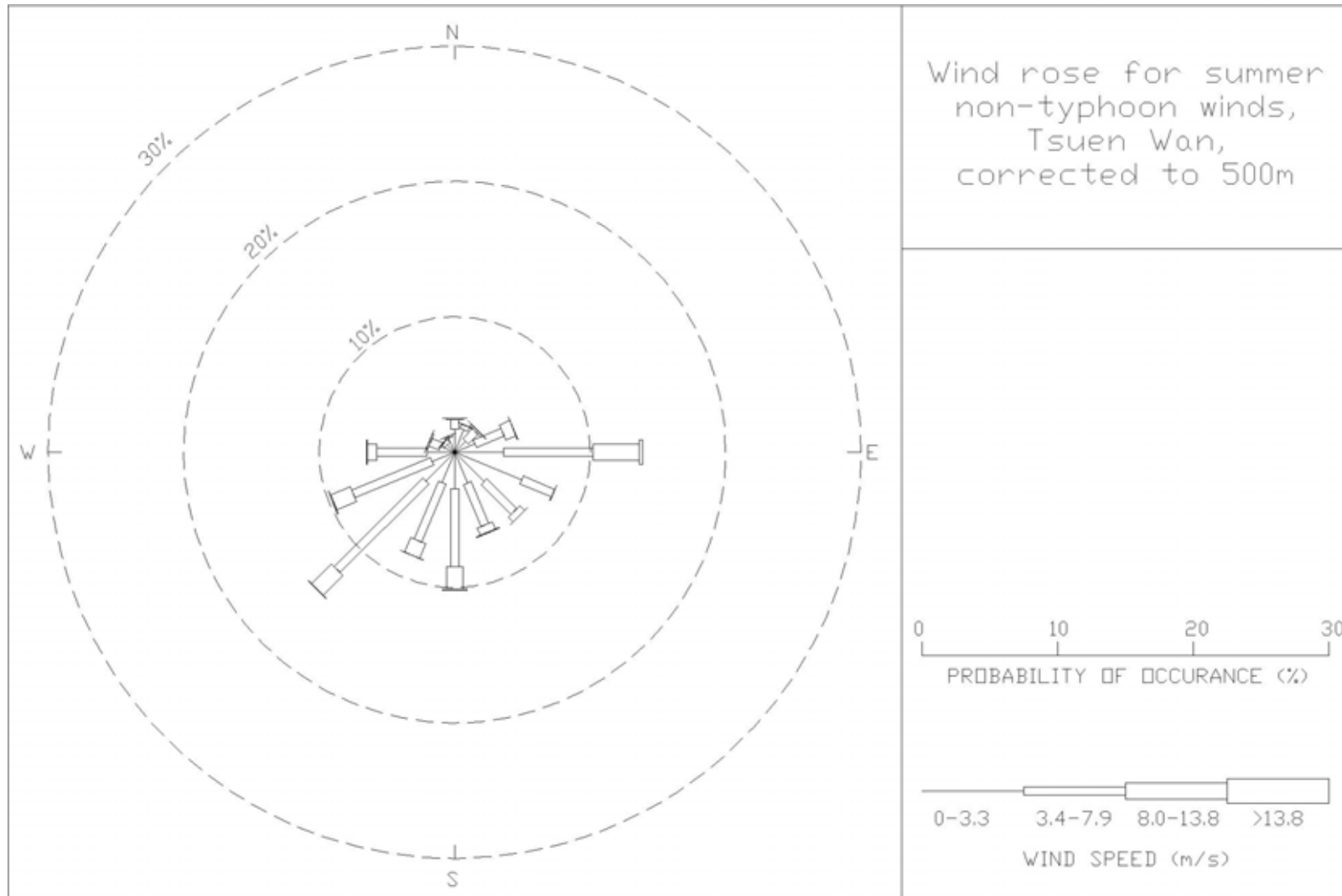

Figure 31: Wind rose for summer, non-typhoon winds for Tsuen Wan, existing configuration, corrected to 500m

APPENDIX A: TABULATED RESULTS FOR TSUEN WAN

Table A1: Site wind characteristics, Tsuen Wan, 22.5°

Prototype scale height (mPD)	Normalized mean wind speed	Turbulence intensity (%)	Yaw angle (°)	Pitch angle (°)
25	0.33	22.9	5.2	-2.9
50	0.37	21.7	4.9	-3.1
75	0.39	21.9	4.6	-2.8
100	0.42	22.0	3.5	-2.7
150	0.47	21.5	2.7	-1.9
200	0.51	20.6	1.7	-1.5
300	0.56	19.6	2.9	-0.8
400	0.59	19.2	4.3	-0.6
500	0.62	18.7	5.3	-0.5

Table A2: Site wind characteristics, Tsuen Wan, 45°

Prototype scale height (mPD)	Normalized mean wind speed	Turbulence intensity (%)	Yaw angle (°)	Pitch angle (°)
25	0.35	21.5	11.5	-4.8
50	0.40	22.7	9.0	-4.8
75	0.44	22.0	7.8	-4.8
100	0.49	21.1	6.6	-4.9
150	0.58	18.5	4.4	-4.2
200	0.63	17.0	3.4	-4.0
300	0.71	15.4	2.4	-3.7
400	0.79	13.8	2.3	-3.9
500	0.86	12.5	2.4	-3.6

Table A3: Site wind characteristics, Tsuen Wan, 67.5°

Prototype scale height (mPD)	Normalized mean wind speed	Turbulence intensity (%)	Yaw angle (°)	Pitch angle (°)
25	0.34	23.6	4.9	-4.0
50	0.39	23.0	5.5	-4.9
75	0.43	22.2	6.7	-5.2
100	0.46	21.6	7.4	-5.1
150	0.52	20.1	7.6	-4.3
200	0.57	18.8	7.7	-3.6
300	0.66	17.0	7.2	-2.8
400	0.73	14.7	6.6	-2.3
500	0.82	12.6	6.0	-2.1

Table A4: Site wind characteristics, Tsuen Wan, 90°

Prototype scale height (mPD)	Normalized mean wind speed	Turbulence intensity (%)	Yaw angle (°)	Pitch angle (°)
25	0.32	31.1	17.3	-4.1
50	0.37	32.1	15.3	-5.7
75	0.42	30.8	13.1	-7.0
100	0.48	28.5	11.3	-7.2
150	0.60	23.4	8.0	-6.5
200	0.72	17.3	6.8	-5.6
300	0.83	11.2	7.0	-4.4
400	0.89	9.7	7.0	-4.1
500	0.92	8.8	7.1	-3.6

Table A5: Site wind characteristics, Tsuen Wan, 112.5°

Prototype scale height (mPD)	Normalized mean wind speed	Turbulence intensity (%)	Yaw angle (°)	Pitch angle (°)
25	0.26	30.4	26.0	-0.8
50	0.28	29.3	23.6	-3.0
75	0.30	28.6	21.7	-3.4
100	0.32	28.1	20.3	-3.5
150	0.37	26.7	17.7	-2.8
200	0.40	24.7	16.2	-1.4
300	0.47	21.8	13.0	1.3
400	0.51	21.0	9.4	1.7
500	0.55	20.4	6.8	2.0

Table A6: Site wind characteristics, Tsuen Wan, 135°

Prototype scale height (mPD)	Normalized mean wind speed	Turbulence intensity (%)	Yaw angle (°)	Pitch angle (°)
25	0.26	32.8	22.2	-3.8
50	0.29	32.8	19.6	-4.8
75	0.32	32.4	17.7	-5.2
100	0.35	31.6	15.7	-5.0
150	0.42	29.3	11.6	-4.4
200	0.49	26.1	9.8	-3.5
300	0.62	20.7	8.6	-2.5
400	0.72	17.4	8.9	-1.6
500	0.82	13.7	9.2	-1.4

Table A7: Site wind characteristics, Tsuen Wan, 157.5°

Prototype scale height (mPD)	Normalized mean wind speed	Turbulence intensity (%)	Yaw angle (°)	Pitch angle (°)
25	0.36	18.1	0.2	-0.9
50	0.38	18.8	3.6	-0.7
75	0.41	19.9	6.0	-1.3
100	0.45	20.7	6.9	-1.7
150	0.54	19.8	5.9	-1.1
200	0.64	16.6	4.2	-0.4
300	0.80	10.0	2.3	0.9
400	0.86	7.9	2.3	1.1
500	0.88	7.1	2.4	1.5

Table A8: Site wind characteristics, Tsuen Wan, 180°

Prototype scale height (mPD)	Normalized mean wind speed	Turbulence intensity (%)	Yaw angle (°)	Pitch angle (°)
25	0.40	21.5	-10.3	2.4
50	0.42	22.2	-4.6	1.8
75	0.45	22.7	0.0	1.5
100	0.50	21.5	1.6	1.0
150	0.64	15.8	0.8	1.0
200	0.77	9.8	-0.4	1.5
300	0.82	7.7	-0.4	1.9
400	0.85	7.3	0.1	2.2
500	0.88	6.8	0.3	2.4

Table A9: Site wind characteristics, Tsuen Wan, 202.5°

Prototype scale height (mPD)	Normalized mean wind speed	Turbulence intensity (%)	Yaw angle (°)	Pitch angle (°)
25	0.39	19.4	-0.5	-2.4
50	0.42	21.2	0.1	-1.5
75	0.46	21.6	0.8	-0.6
100	0.50	21.5	1.1	0.0
150	0.60	18.8	-0.3	0.7
200	0.68	15.2	-2.0	1.1
300	0.74	12.2	-4.2	1.4
400	0.77	11.5	-5.5	1.5
500	0.82	10.6	-6.0	1.7

Table A10: Site wind characteristics, Tsuen Wan, 225°

Prototype scale height (mPD)	Normalized mean wind speed	Turbulence intensity (%)	Yaw angle (°)	Pitch angle (°)
25	0.35	27.2	-8.3	0.6
50	0.38	27.2	-7.7	0.6
75	0.41	27.2	-6.9	0.7
100	0.44	27.0	-5.8	0.7
150	0.50	25.0	-5.6	1.4
200	0.57	22.8	-5.2	1.7
300	0.68	18.3	-4.2	2.7
400	0.78	14.2	-3.5	3.0
500	0.85	11.1	-3.3	3.3

Table A11: Site wind characteristics, Tsuen Wan, 247.5°

Prototype scale height (mPD)	Normalized mean wind speed	Turbulence intensity (%)	Yaw angle (°)	Pitch angle (°)
25	0.58	11.8	7.1	-1.3
50	0.61	12.6	5.4	-1.2
75	0.63	12.7	4.0	-1.2
100	0.65	13.0	3.1	-1.0
150	0.70	13.0	2.4	-0.6
200	0.75	12.5	2.2	-0.3
300	0.79	11.4	2.7	0.8
400	0.82	10.3	2.8	1.6
500	0.87	9.0	2.6	2.1

Table A12: Site wind characteristics, Tsuen Wan, 270°

Prototype scale height (mPD)	Normalized mean wind speed	Turbulence intensity (%)	Yaw angle (°)	Pitch angle (°)
25	0.49	15.2	5.1	-2.3
50	0.54	15.3	5.5	-1.6
75	0.59	14.4	5.7	-1.2
100	0.64	13.4	6.0	-0.5
150	0.69	12.1	5.9	0.3
200	0.74	11.3	5.6	0.5
300	0.79	10.3	5.1	0.9
400	0.83	9.8	4.5	1.0
500	0.88	9.2	4.0	0.9

Table A13: Site wind characteristics, Tsuen Wan, 292.5°

Prototype scale height (mPD)	Normalized mean wind speed	Turbulence intensity (%)	Yaw angle (°)	Pitch angle (°)
25	0.48	15.1	13.0	-2.7
50	0.51	15.7	12.5	-2.7
75	0.55	15.8	12.3	-2.5
100	0.58	15.3	11.8	-2.2
150	0.62	14.8	10.7	-1.6
200	0.66	14.3	9.6	-1.3
300	0.71	13.9	7.0	-0.6
400	0.77	12.8	5.3	-0.3
500	0.84	11.2	4.8	0.3

Table A14: Site wind characteristics, Tsuen Wan, 315°

Prototype scale height (mPD)	Normalized mean wind speed	Turbulence intensity (%)	Yaw angle (°)	Pitch angle (°)
25	0.45	17.9	15.5	-3.7
50	0.49	18.4	15.3	-4.1
75	0.53	18.6	14.7	-4.3
100	0.57	18.3	14.6	-4.5
150	0.64	17.4	13.2	-4.2
200	0.69	16.0	12.4	-3.9
300	0.79	13.6	11.2	-3.6
400	0.87	11.3	10.2	-3.4
500	0.94	9.0	10.0	-3.1

Table A15: Site wind characteristics, Tsuen Wan, 337.5°

Prototype scale height (mPD)	Normalized mean wind speed	Turbulence intensity (%)	Yaw angle (°)	Pitch angle (°)
25	0.44	15.5	13.7	-2.2
50	0.46	17.1	12.0	-2.1
75	0.47	17.8	11.4	-1.9
100	0.50	18.0	10.2	-1.9
150	0.55	17.9	8.7	-1.5
200	0.59	17.0	6.9	-1.3
300	0.65	16.1	5.5	-0.5
400	0.71	14.7	4.0	-0.4
500	0.78	12.9	3.1	-0.4

Table A16: Site wind characteristics, Tsuen Wan, 360°

Prototype scale height (mPD)	Normalized mean wind speed	Turbulence intensity (%)	Yaw angle (°)	Pitch angle (°)
25	0.43	20.5	4.8	-3.7
50	0.47	20.3	3.7	-4.5
75	0.51	20.1	3.2	-4.7
100	0.54	20.2	2.6	-4.5
150	0.60	18.4	1.8	-4.3
200	0.66	17.2	1.0	-4.1
300	0.74	15.1	0.0	-4.2
400	0.80	13.6	-0.3	-3.6
500	0.86	11.5	-0.2	-3.6

APPENDIX B: AXIS SYSTEM OF THE COBRA PROBE

The following figures show the standard axis system of the Cobra Probe:

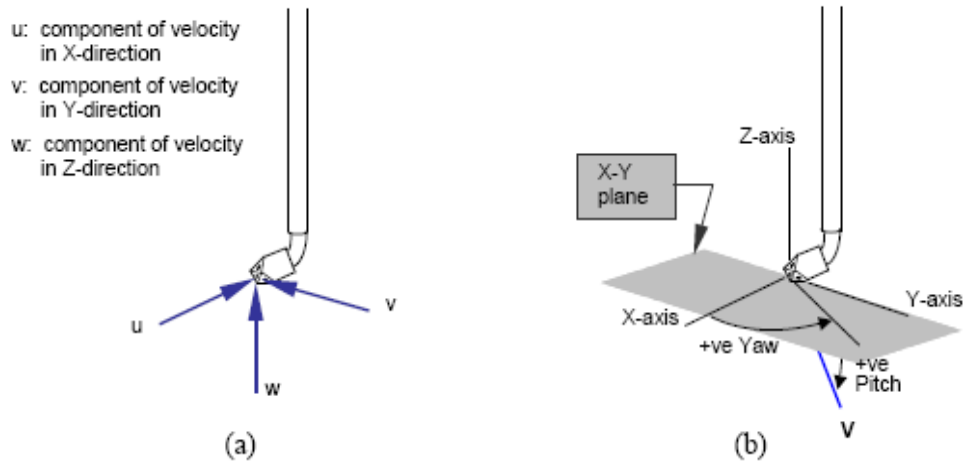

Figure B1: (a) Flow axis system with respect to the Cobra Probe head;
(b) Positive flow pitch and yaw angles

Note: Yaw angle is technically 'azimuth' (rotation angle about the z-axis); Pitch angle is technically 'elevation' (the angle between the flow velocity vector V and the X-Y plane).